

UNILUX

Harmony at work



/An international company



Contact us

- 1** UNILUX
17 avenue du Parc (Technopolis)
91380 Chilly Mazarin
FRANCE
Tel: +33 1 81 86 06 00
E-mail: contact.unilux@hamelinbrands.com
- 2** HAMELIN S.A.S
Avenue General Harris
14054 Caen cedex 4
FRANCE
Tel: +33 2 14 40 62 00
E-mail: info.hamelin@hamelinbrands.com
- 3** HAMELIN BRANDS LIMITED
Kings Warren Business Park
IP28 8WG Red Lodge
UK
Tel: +44 1638 554 524
E-mail: marketing.uk@hamelinbrands.com
- 4** HAMELIN GMBH
Robert-Hamelin-Strasse 1
31028 Gronau (Leine)
GERMANY
Tel: +49 5182 901 0
E-mail: info.hamelinde@hamelinbrands.com
- 5** HAMELIN BRANDS S.L.U.
Ctra. C-66 Km. 22.60
17463 Flaca
SPAIN/ PORTUGAL
Tel: +34 901 100 069
E-mail: Unilux.iberia@hamelinbrands.com
- 6** HAMELIN NORDIC
Noeglegaardsvej 1
340 Lyngø
DENMARK
Tel: +45 48 16 50 00
E-mail: csdk@hamelinbrands.com
- 7** HAMELIN BV
Celsiusweg 35b
5928 PR Venlo
NETHERLANDS
Tel: +31 77 373 15 51
E-mail: sales.hamelinnl@hamelinbrands.com
- 8** FAVORIT SPA
piazza Don Mapelli 1
20099 Sesto San Giovanni (MI)
ITALY
Tel: +39 02 2590591
E-mail: info.hamelinit@hamelinbrands.com
- 9** HAMELIN POLAND
Ryzowa 49,
02-495 Warsaw
POLAND
Tel: +48 22 589 51 11
E-mail: info.hamelinpl@hamelinbrands.com
- 10** HAMELIN BRANDS INC
Amherst Works
11 Amity Street- Amherst, MA 01002
USA
Tel: +1 800 674 7018
E-mail: info@hamelinbrandsinc.com
- 11** HAMELIN BRANDS PTY. LTD.
17 Interchange Drive,
Eastern Creek NSW
2766 AUSTRALIA
Tel: +61 1300 655 667
E-mail: customersupport.au@hamelinbrands.com

/Sum up

Our vision.....	p 2
Our expertise.....	p 4
Our eco-responsible commitment	p 5
Lighting	p 7
<i>Measurement of light and physical quantities.....</i>	p 9
<i>The importance of good lighting.....</i>	p 11
● Office uplighters.....	p 13
● Connected lamps.....	p 31
● Design lamps.....	p 35
● Double arm lamps and architectural lamps.....	p 57
● folding lamps.....	p 67
● Battery lamps.....	p 73
● Shade lamps.....	p 75
● Magnifying lamps.....	p 79
Ergonomics.....	p 87
<i>Responses to musculoskeletal disorders</i>	p 89
<i>How to fight against a sedentary lifestyle?.....</i>	p 91
● Support-arm screen.....	p 92
● Gantry of storage.....	p 94
● Wrist Rest.....	p 95
● Footrests.....	p 96
● Ergonomic sitting-stand.....	p 102
● Height Adjustable Desk - Adjustable Platform.....	p 104
Air purifiers.....	p 107
<i>Healthy air.....</i>	p 108
● By filtration.....	p 112
● By photocatalyse.....	p 114
Clocks.....	p 117
● Quartz clocks.....	p 118
● Silent clocks.....	p 122
● Radio-controlled clocks.....	p 126
Reception.....	p 129
● Coat pegs.....	p 130
● Coat stands.....	p 134
● Garment racks.....	p 142
● Coat hangers.....	p 142
Products range - alphabetical order.....	p 145
Notes.....	p 153



/Our mission:

Consists of contributing to better health in the office, by proposing innovative and effective products while respecting the requirements of safety, respect for the environment and Men. By meeting the needs of the 5 senses of the person, our ambition is to increase the well-being, productivity in the office.

UNILUX wishes to promote through its products the exchanges between employees, their concentration, their mobility, the aesthetics of their work environment and the image of the company.

1- Lighting workspaces

Light influences our concentration at work. The careful selection of UNILUX light sources reduces fatigue and headaches. UNILUX designs new lamps to regulate our circadian cycle, a biorhythm that regulates sleep, digestion, body temperature, cell reproduction and even our mood.

2- Improve ergonomics at work

With ergonomists and osteopaths, UNILUX creates revolutionary ergonomic products adapted to office life. Ergonomic seating, lift desks and footrests promote dynamic postures, stimulating blood circulation, joint movement and reducing back pain.

3- Create aesthetic workplaces

In connection with interior designers, UNILUX invents products with “trendy” design and pleasant working universes. These ambiances provide more pleasure and motivation for employees for better quality and a revitalized corporate image.

4- Respond to new work modes driven by “Digital native”

Collaborate, connect, exchange, move, share, live in the office and at home, UNILUX supports the changes of lifestyle at work with modular organizational solutions.

/Our 360 ° vision

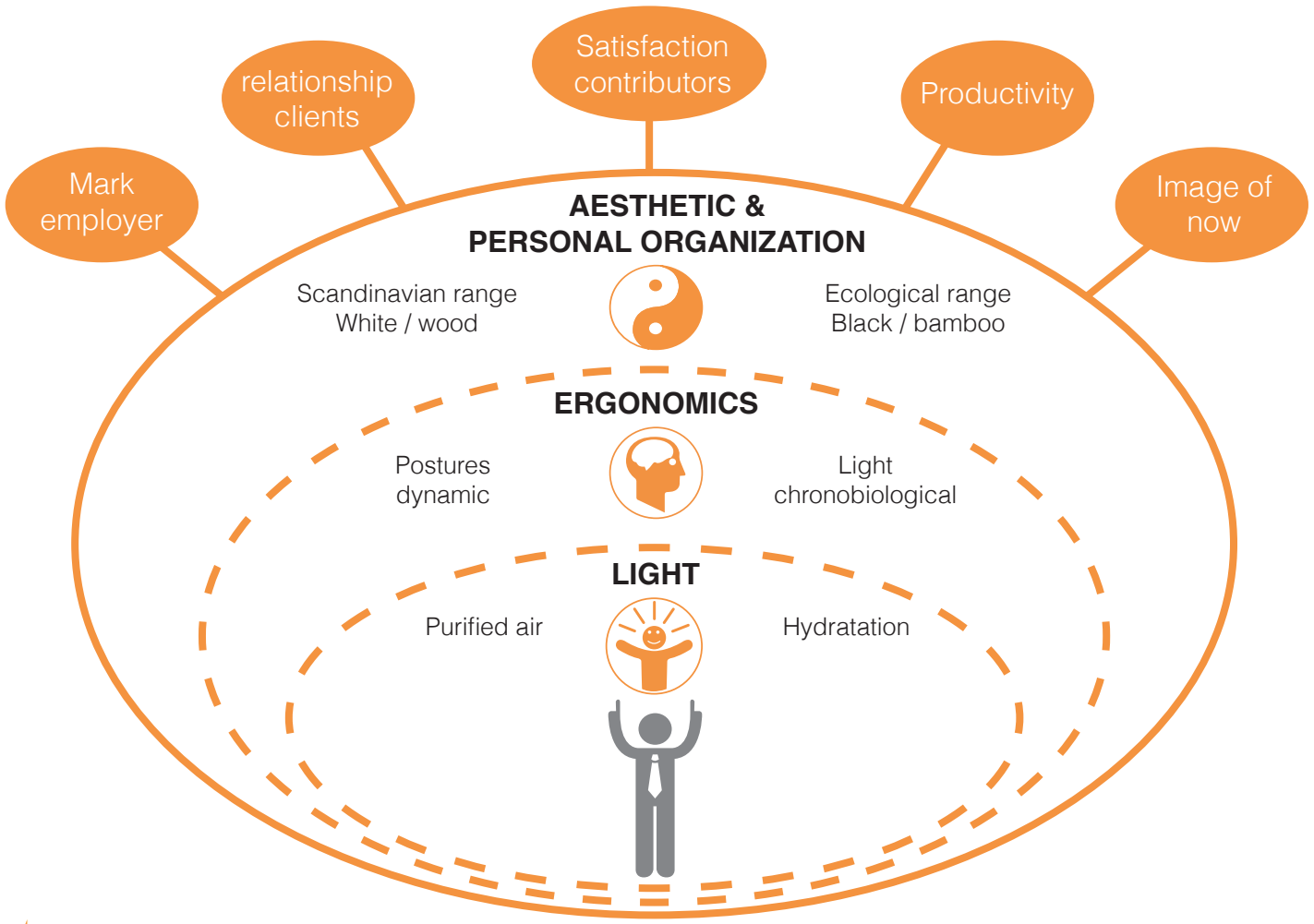

/Our values:

Innovation and Design

Empathy, Respect and Well-Being

Quality/ Excellence and Expertise



/Our expertise

From ideation to industrialization

1- Idéation



Creation and innovation are at the heart of UNILUX's DNA. We follow a rigorous process of creativity called "Design Thinking" allowing us to empathize with our consumers to better meet their expectations. Our goal is to provide the best user experience to our customers.

2- Conception



The development of our ranges is based on a multidisciplinary approach that takes into account all the requirements to preserve the environment, by:

- the choice of materials used
- reducing the energy consumption of our lamps using the latest LED technologies
- optimization of packaging and logistics aspects

3- Performance measurement



UNILUX measures the performance of prototypes and pre-series before the industrial launch. The control of photometry and mechanical tests are therefore perfectly controlled internally and validated by external laboratories.

4- Quality and continuous improvement



Quality is our priority. Certified ISO 9001, 14001 and 45001 Unilux guarantees a thorough control of its products on the production lines. Sampling of finished products is tested on all expected functional performance. Daily monitoring of our level of quality makes it possible to systematically engage in continuous improvement actions.

5- Customer service



UNILUX ensures the permanent link with its customers thanks to a CRM and a team dedicated to the service. The availability of UNILUX products throughout Europe is guaranteed by the centralized management of the supply chain and the most efficient digital tools.





/ Our eco-responsible commitment

An actor committed to the eco-responsibility and sustainability of its products

UNILUX places sustainable development at the heart of its strategy and acts in favor of the environment. UNILUX is certified ISO 9001- Safety ISO 45001- Environment ISO 14001. UNILUX is part of a continuous improvement process that includes all stakeholders.

UNILUX aims to meet the environmental concerns of its consumers by ensuring that environmental impacts are reduced or controlled. UNILUX ensures the regulatory compliance of all its products (prescriptions: ROHS, REACH, WEEE ...). UNILUX chooses reusable materials as a priority.

UNILUX lamps are equipped with LED bulbs and latest generation LED cards that guarantee low power consumption thanks to excellent light output. They also ensure a longer life.

To promote energy savings, some UNILUX lamps are also programmed to turn off after a few hours.



/Lamps and uplighters

1

Create consistent lighting on the workstation

SOLUTIONS

OFFICE UPLIGHTERS

p 13 to p 17

2

Reboost at work

SOLUTIONS

CONNECTED LAMPS

p 18 to p 21

3

Reduce eye strain

SOLUTIONS

DESIGN LAMPS

p 35 to p 55

4

Improve visual comfort

SOLUTIONS

DOUBLE ARM LAMPS
ARCHITECT LAMPS

p 57 to p 65

5

Save space on the workspace

SOLUTIONS

FOLDING LAMPS

p 67 to p 71

6

In the office or take away anywhere on the move

SOLUTIONS

BATTERY LAMPS

p 72 to p 73

7

Bring a decorative touch to the office

SOLUTIONS

SHADE LAMPS

p 75 to p 77

8

Recommend for precision work

SOLUTIONS

MAGNIFYING LAMPS

p 79 to p 81

Features



ON/OFF



Adjustable color temperature



Wireless charger



Intensity dimmer



Automatic shutdown



USB port



Tactile dimmer of intensity



asymmetric lighting



Light sensor



Rechargeable battery



Application "My unilux"

/Measurement of light and physical quantities

Illuminance (Lux)

corresponds to a quantity of light received by a surface. So: $E = \frac{\Phi}{S}$

- Φ : luminous flux in Lumen
- S : surface per m^2

Recommended lighting according to DIN EN 12464-1 * for the office

- 300 Lux : deposit, copy, traffic areas
- 500 Lux : writing, reading, data processing
- 500 Lux : at the reception and at the counter
- 750 Lux : technical drawinge

* DIN EN 12464-1 (DIN 5035-1): European standard that determines the lighting requirements of workstations in enclosed areas, which meet the requirements of comfort and visual performance. DIN EN 12464-1 has replaced DIN 5035-1

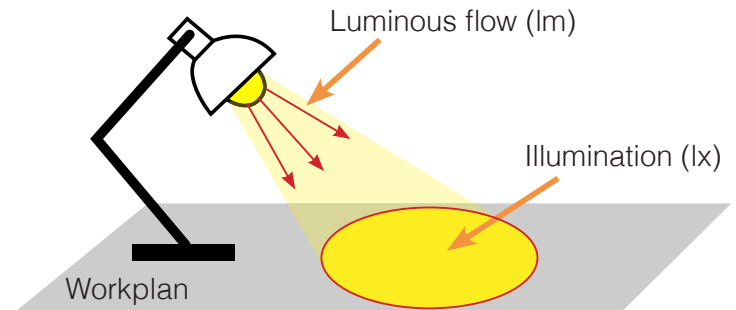

Illumination diagrams

correspond to the two graphs shown opposite, they allow to determine the illumination of your office at a certain distance. The vertical and horizontal axes indicate the illumination (Lux) at a given distance between the source and the office. The maximum illumination is at the origin of the two axes and decreases by moving either laterally or longitudinally with respect to the origin.

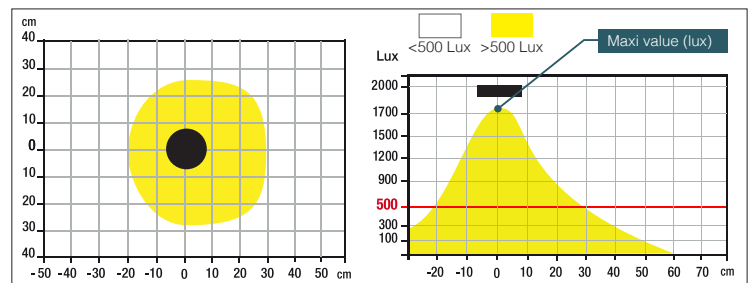

Luminous flux (lm)

is defined by the sum of all the radiations emitted by the lamp. It is measured in Lumen, "lm" for short. It is defined from the energy flux (expressed in watts) more often termed radiated power.

The latter is a flow of radiated energy:

$$\Phi = \frac{Q}{t}$$

where Q is the radiated energy, expressed in joules (J) and t in seconds (s)

Luminous efficiency (lm/W)

corresponds to the luminous efficiency of the lamp. This value is established by the ratio between the luminous flux and the power consumed. It is measured in "lm / W". The higher the luminous efficiency, the higher the amount of light relative to the power consumed. This data is fundamental for the preservation of the environment since it allows us to reduce energy consumption for the same amount of light emitted.

Color temperature (Kelvin)

is defined by the color emitted by the light source. Variation in color temperature is an essential function of the desk lamp in addition to the variation of the intensity, as it allows to customize the lighting and to adapt the appropriate color temperature to the different activities (computer work , concentration, reading, relaxation, rest, ...). This variation in color temperature is measured in "Kelvin", "K" for short.

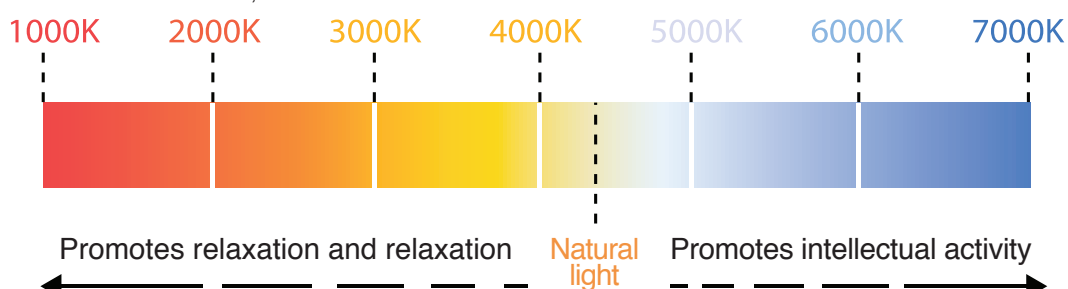

Light intensity (cd)

measures the power of a light beam. It indicates the proportion of the luminous flux emitted in a certain direction. The unit is the candela (cd).

Luminance

measures the impression of brightness perceived by the observer's eye when viewing a luminaire or illuminated surface of an object. The unit is the candela / square meter (cd /m²).

Glare

Characterized by the UGR standard which is a measure of the brightness in a given environment, this is essentially the logarithm of the glare of all visible lamps, divided by the background brightness. We distinguish two forms of glare:

Direct glare

intervenes when a bright light is directly in the field of vision (lamp, luminescent tube, window, ...).

Indirect glare

intervenes by the reflection of the light in the field of vision, on a work plan, on walls or on objects.

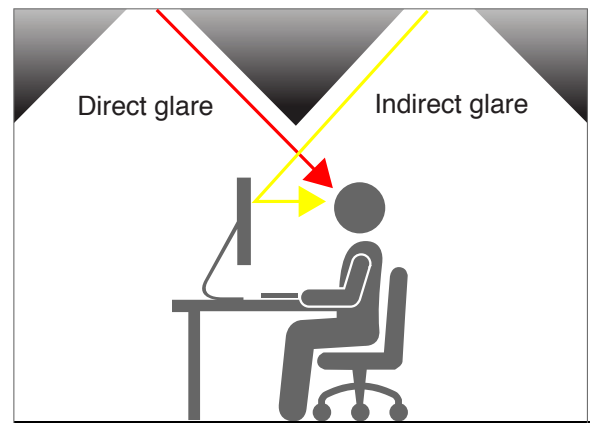

Symmetrical and asymmetric lighting

is designed to efficiently bring light to a desired place.

Symmetrical lighting

is defined by a work lamp that distributes the light evenly over the work surface.

This can contribute a benefit for conference tables, in stores, etc.

Asymmetrical lighting

is suitable for work on the computer. The light is tilted to neutralize annoying reflections on the screen.

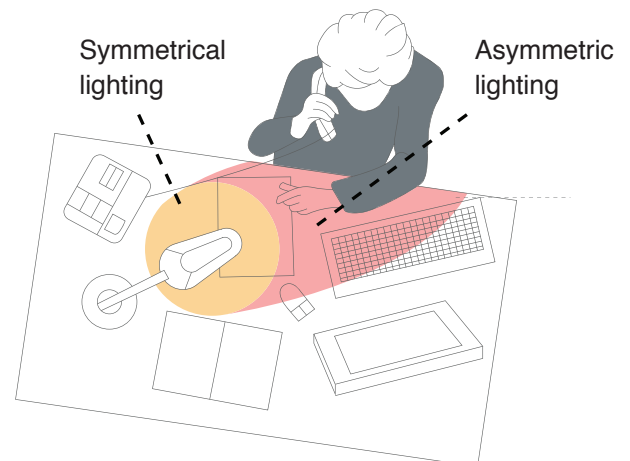

Color index (CRI)

is the value used to describe the quality of the color rendering of the light sources. The color rendering index is often referred to by the abbreviation "CRI". A value greater than or equal to 80 corresponds to good color rendering.



LED is an economical, efficient and ecological source

In fact, compared to fluorescent and halogen bulbs, LEDs consume 2 to 10 times less energy. Their lifespan is 10 to 100 times higher than other light sources. Their environmental impact is excellent, it is 75% less than an incandescent bulb.

Safe for health

UNILUX lamps are tested to ensure the absence of photobiological risks in accordance with the standard NF-EN-62471

* recommended by the ANSES **.

* NF-EN-6247: International Standard Provides a Guide for the Evaluation of the Photobiological Safety of Lamps and Apparatus Using Lamps

** ANSES: National Agency for Food Safety, Environment and Labor

/The importance of good lighting

Today : reduce eyestrain

The global market share of LEDs is about 12% and is expected to reach 80% by 2020. The sector knows growth of about 30% per year and could represent "a large part of the lighting" according to ADEME *. The share of what could represent LEDs in 2020 on the global market will be 75 billion euros.

Health and well-being at work are two notions that are growing expectations for other businesses. According to recent studies, anxiety, stress, and the work environment are at the heart of employees' concerns. Poor lighting quality is one of the sources of discomfort cited by employees:

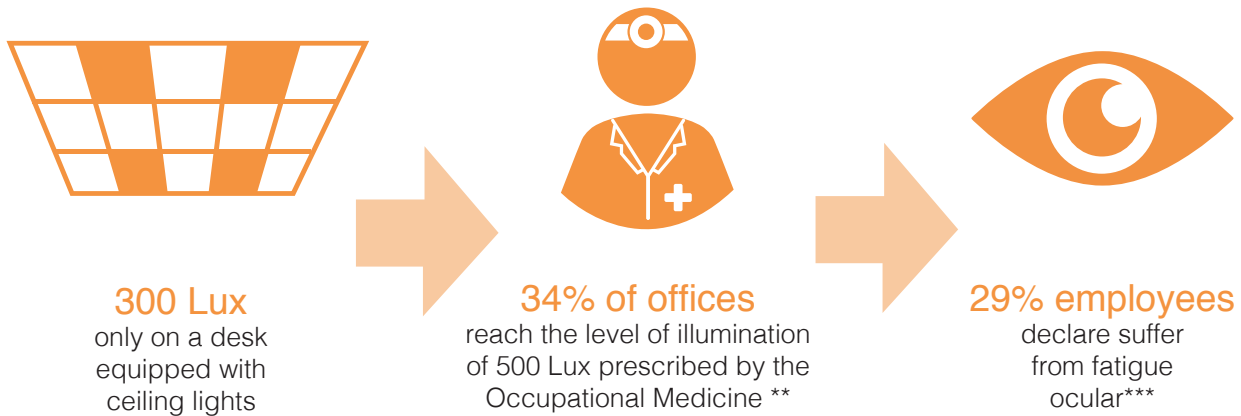

The results

We are regularly subjected to constant artificial lighting at the office which does not take into account the biological rhythm. Unsuitable lighting can cause :

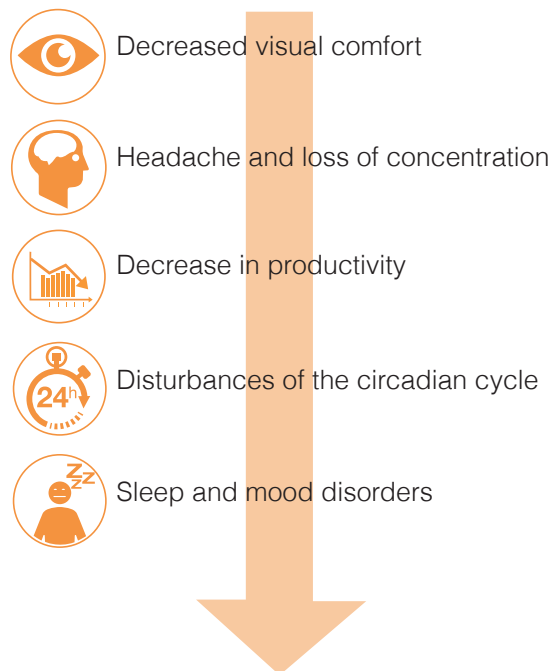

Proper lighting is essential for working on a workstation in acceptable and comfortable conditions (reading, writing, computer work, concentration, ...).

* ADEME: Environment and Energy Management Agency

** Standard NF EN 12 464-1 (European standard): Requirement for lighting indoor workplaces

*** Source: <http://www.recrutons.fr/ergonomie-de-poste-de-travail.html>

/The benefits of light

Tomorrow: reboosting by optimizing the circadian rhythm

Natural light is as important to health as balanced food, regular exercise and sleep. This natural light helps keep you healthy and acts on the circadian rhythm for millions of years.

What is the circadian rhythm?

It is the biological rhythm that regulates the heart rate and body temperature, acting in particular on sleep, mood, memory and even cognitive abilities.

What is it influenced by?

By the daily contribution of natural light. This plays a fundamental role on the biological clock and on the secretion of hormones such as melatonin, the rate of which increases the sensation of sleep. A white light will reduce it while it will increase, in the evening, with a more yellow light. And yet, office workers are daily subjected to constant artificial lights! A cold white light enhances the performance in the morning or after your lunch break, while a warm yellow light in the evening is the signal of relaxation and prepare your sleep to come. This adapted light stabilizes the circadian rhythm over the long term. This stabilization results in greater well-being, better sleep and therefore improved efficiency and increased productivity throughout the day.

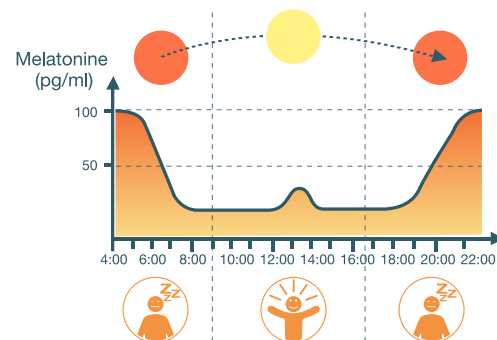
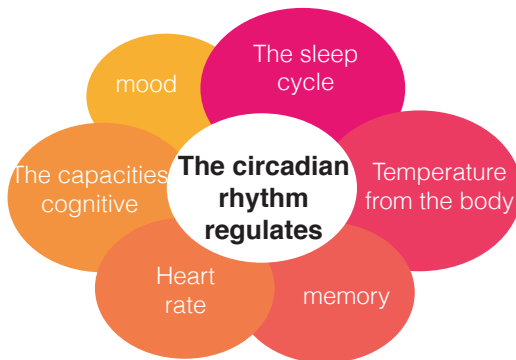

The UNILUX solution : our range of connected lamps

UNILUX has developed a range of lamps controlled by the innovative application "My unilux" to synchronize the circadian rhythm of people by simulating sunlight and its impact on the regulation of secretion of melatonin and serotonin. By providing the right quality of light at the right time of day, "My unilux" manually or automatically varies the intensity and color temperature according to a circadian cycle pre-programmed or customizable depending on the course of the day. This range of lamps consumes less energy than traditional light sources thanks to its automatic extinction related to the presence or absence of the user.

Their combined designs and technologies make this Unilux range unique.

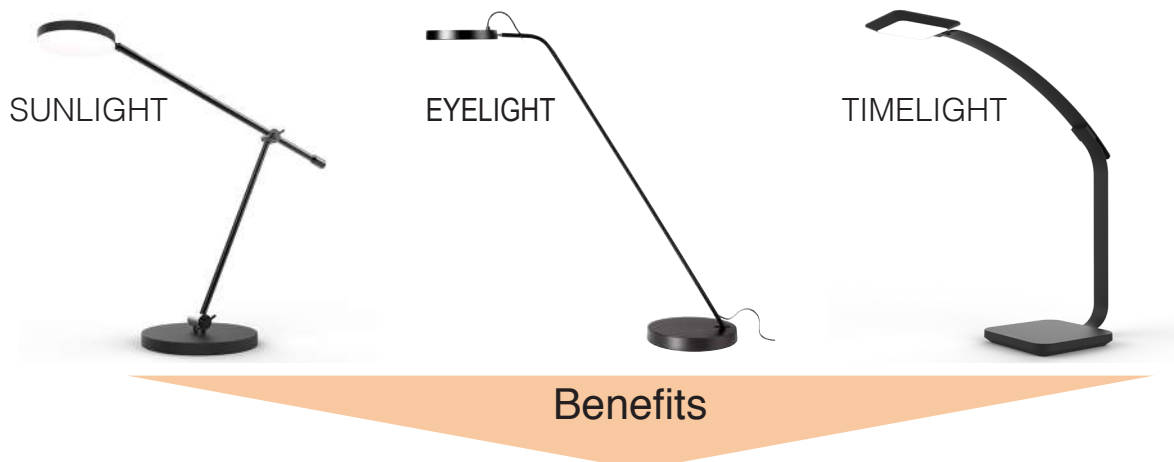

- Decreases disturbances of the circadian rhythm
- Limits the risks of insomnia, irritability and mood disorders
- Reduces lack of concentration
- Strengthens your alertness and your memory
- Increases intellectual performance
- Regulates the production of melatonin



- **Easy to use:** its push button on the mast allows you to adjust the intensity of your lighting according to your professional activities (read, write and work).
- **Luminous efficiency:** the emissive surface, semi-transparent at extinction, offers in operation a very large extended flux and a good uniformity.
- **Visual comfort:** the light guided in the fins is restored on the entire surface of the luminaire thus providing excellent visual comfort (low luminance and very good UGR less than 17).
- **Finesse and discretion:** with a thickness of only 6 mm on both sides, the profile of the ORIUS is characterized by clean lines, a union of lines and discrete curves.
- **Transparency:** its discreet presence promotes the development of workspaces.
- **Intelligent:** automatic adjustment of the intensity according to the ambient brightness and energy savings thanks to its brightness sensor and its cell with presence detection.
- **Stability:** the base cut out of 8 mm thick sheet metal makes it possible to position the floor lamp as close as possible to an office or table base.
- **Floor lighting:** mobile, it is suitable for lighting 2 stations with excellent uniformity.

- Rated power: this luminaire contains integrated LED lamps with a power of 90.6 W which can not be replaced
- Lifetime *: 50,000 hours
- Illumination of 1190 Lux at 110 cm down and 2984 Lux at 55 cm upwards, luminous flux 11460 lumens (direct + indirect)
- Color temperature: 4000 K
- Weighted energy consumption: 75.5 kWh / 1000 h
- Luminous efficiency ** of LEDs: 140 lm / W
- Energy efficiency: class A / A + / A ++ (spectrum A ++ to E)
- CRI: 90
- 2 years warranty
- White colour
- Materials: high quality steel base with epoxy paint finish / recyclable aluminum mast and plexiglass head

* Average consumption: 1000 h / year
 ** Light emission of the lighting source

Suspension on request



Configurations: contact us

- Option 1:** intensity variation + detection cell + brightness sensor
- Option 2:** intensity variation + color temperature variation + detection cell + brightness sensor
- Option 3:** Intensity dimming + separate direct / indirect lighting control + detection cell + brightness sensor

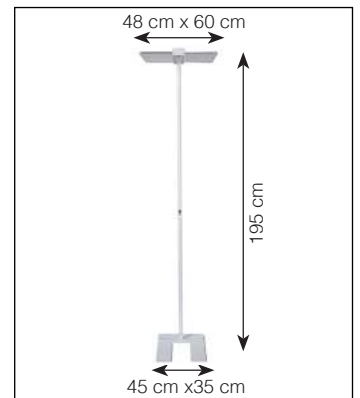

Technical features

Measurement of LUX down to 110 cm from the light source:

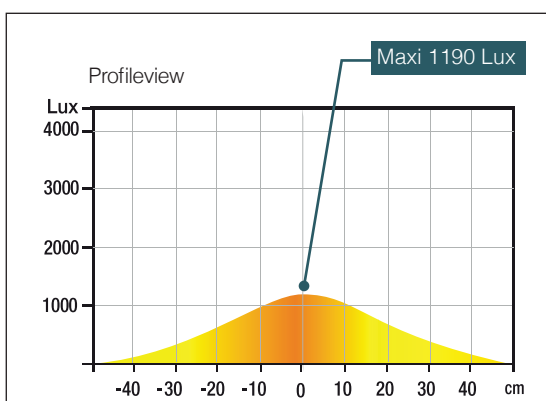

LUX measurement upwards at 55 cm from the light source:

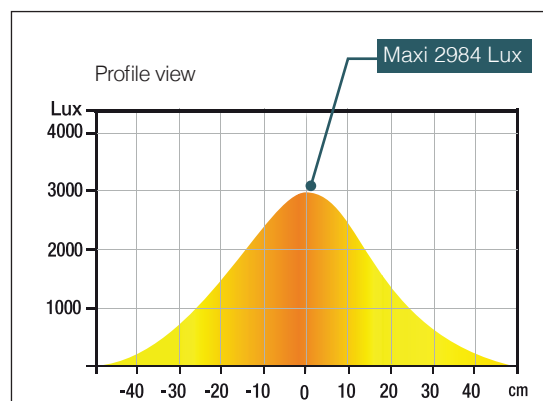

Energy class

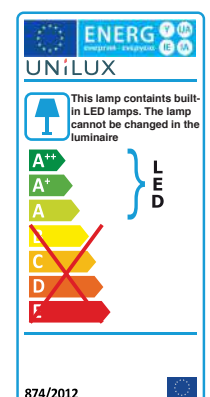

/ OFFICE UPLIGHTERS



● OPTION 1: intensity variation



● OPTION 2: intensity variation and color temperature



● OPTION 3: direct / indirect separate lighting





- **Easy to use:** its push button on the mast allows you to adjust the intensity of your lighting according to your professional activities (read, write and work).
- **Direct illumination by specific optics:** the light of each LED component is directed towards the workspace to create a homogeneous light.
- **High-performance indirect lighting:** with an OSRAM LED system, indirect lighting ensures a bright environment around the office.
- **Finesse and design:** a sleek design line with visual identity as a central light axis.
- **Intelligent:** automatic adjustment of the intensity according to the ambient brightness and energy savings thanks to its brightness sensor and its cell with presence detection.
- **Stability:** the base cut out of 8 mm thick sheet metal makes it possible to position the floor lamp as close as possible to an office or table base.

- Rated power: this luminaire contains built-in LED lamps with a power of 55 W that can not be replaced
- Lifetime *: 50,000 hours
- Illumination of 893 Lux ** at 110 cm downwards and 2100 Lux ** at 55 cm upwards, luminous flux 7600 lumens (direct + indirect)
- Color temperature: 4000 K
- Weighted energy consumption: 46 kWh / 1000 h
- Luminous efficacy *** of LEDs: 130 lm / W
- Energy efficiency: class A / A + / A ++ (spectrum A ++ to E)
- CRI: 82
- 2 years warranty
- White colour
- Materials: base and top quality steel head with epoxy paint finish / recyclable aluminum mast

* Average consumption: 1000 h / year
 ** Estimate (non-contractual data)
 *** Light emission of the lighting source

Suspension on request

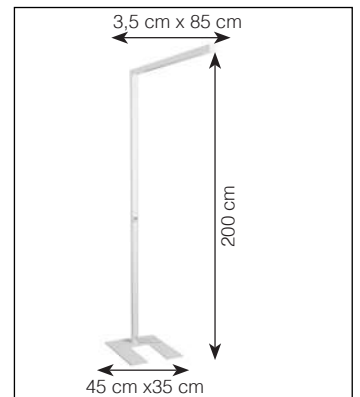

Technical features

Measurement of Lux down to 110 cm from the light source:

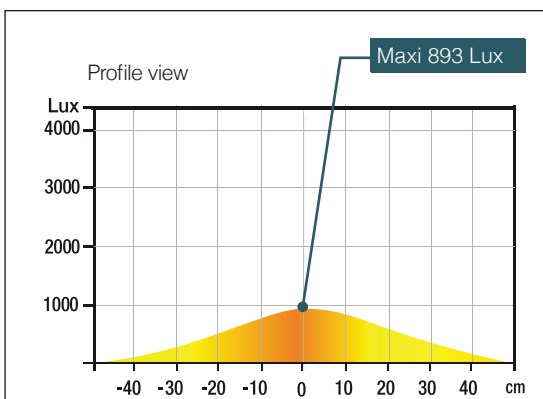

Lux measurement upwards at 55 cm from the light source:

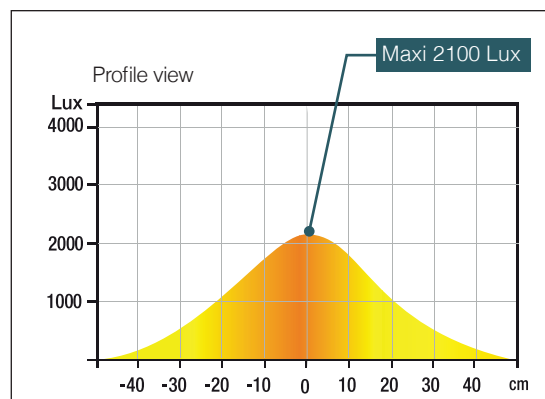

Energy class

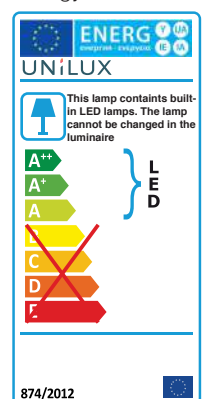

/LIXUS

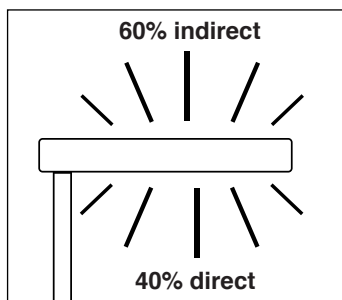

- **Easy to use:** Its dimmer on the mast allows you to find the most comfortable lighting for reading, writing and working.
- **Modern design:** designed with recyclable aluminum, its sleek and clean lines allow to integrate this lamp in both classic and modern decorations.
- **Double effect:** direct 40% glare-free lighting for the work surface and 60% indirect light for ambient light.
- **Equipped with quality LEDs (light-emitting diodes):** this floor lamp emits a non-scintillating light and zero radiation, helping to reduce eye strain. Low energy consumption helps save energy.
- **Stability:** the 8 mm thick sheet metal base allows a good stability of the uplighter.

- Rated power: this luminaire contains integrated LED lamps with a power of 68,4 W which can not be replaced
- Lifetime *: 50,000 hours
- Illumination of 1195 lux at 110 cm down and 3600 lux at 55 cm up
- Color temperature: 4000 K
- Weighted energy consumption: 57 kWh / 1000 h
- Luminous efficiency ** of LEDs: 123 lm / W
- Energy efficiency: class A / A + / A ++ (spectrum A ++ to E)
- CRI: > 80
- 2 years warranty
- Height: 195 cm
- Head: 28 cm x 61cm
- Dimmer on height, height: 120 cm
- Materials: high quality steel base with epoxy paint finish / mast and head in recyclable aluminum

* Average consumption: 1000 h / year
 ** Light emission of the lighting source

Réf. product	Color	Cable length	Code EAN	EA by box
400079771	Metal gray	1,9 m	3595560011155	1 pc.

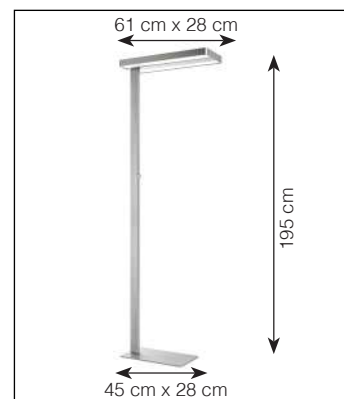

Technical features

Measurement of Lux down to 110 cm from the light source:

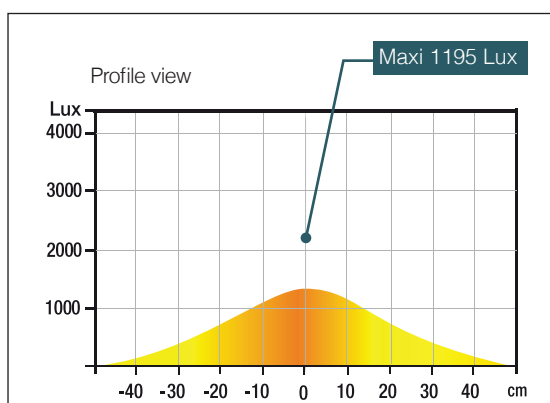

Lux measurement upwards at 55 cm from the light source:

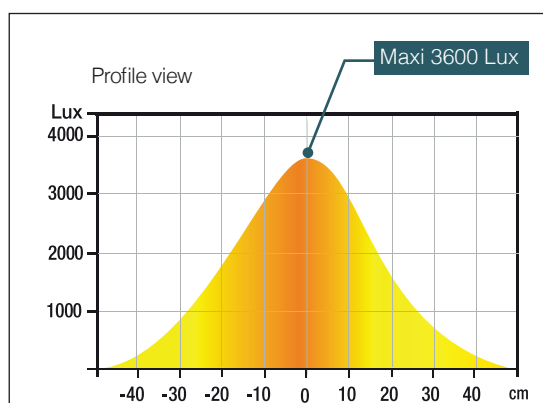

Energy class

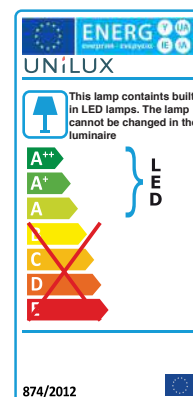

/STRATUS

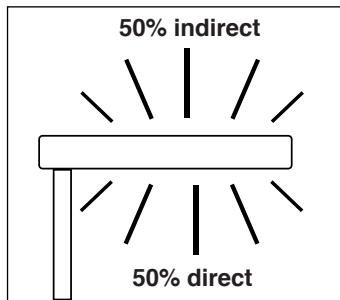
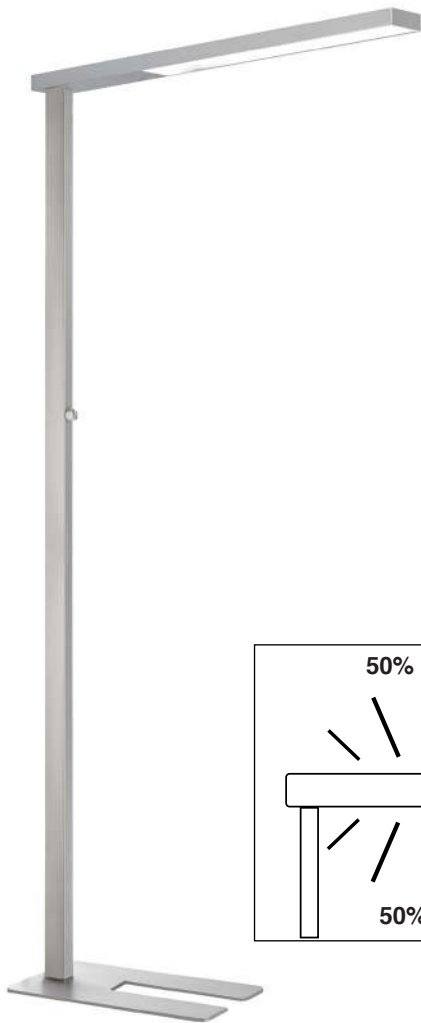

- **Easy to use:** Its dimmer on the mast allows you to find the most comfortable lighting for reading, writing and working.
- **Modern design floor lamp:** designed with recyclable aluminum, its clean and streamlined lines make it possible to integrate this floor lamp in both classic and modern decor.
- **Double effect:** direct 50% glare-free and indirect lighting 50% offers optimal light distribution in your workspace.
- **Equipped with quality LEDs (light-emitting diodes):** this floor lamp emits a non-scintillating light and zero radiation, helping to reduce eye strain. Low energy consumption helps save energy.
- **Stability:** the base cut out of 8 mm thick sheet metal makes it possible to position the floor lamp as close as possible to an office or table base.

- Rated power: this luminaire contains integrated LED lamps with a power of 58,8 W which can not be replaced
- Lifetime *: 50,000 hours
- Illumination of 835 lux at 110 cm downwards and 320 lux at 55 cm upwards
- Color temperature: 4000 K
- Weighted energy consumption: 49 kWh / 1000 h
- Luminous efficiency ** of LEDs: 128 lm / W
- CRI:83
- Warranty: 2 years
- Height: 195 cm
- Head: 6.5cm x 90 cm
- Dimmer on height, height: 120 cm
- Materials: high quality steel base and head with epoxy paint finish / mast in recyclable aluminum

** Average consumption: 1000 h / year
 ** Light emission of the lighting source

Réf. product	Color	Cable length	Code EAN	EA by box
400124564	Metal gray	2,5 m	3595560029587	1 pc.

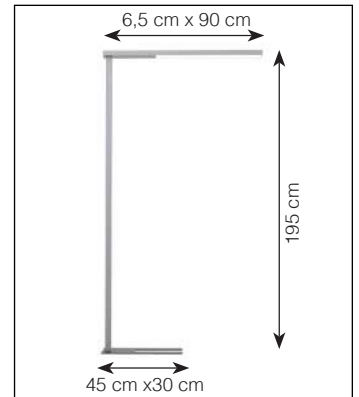

Technical features

Measurement of LUX down to 110 cm from the light source:

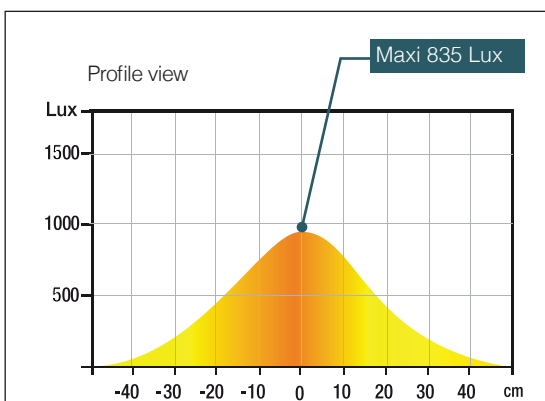

LUX measurement upwards at 55 cm from the light source:

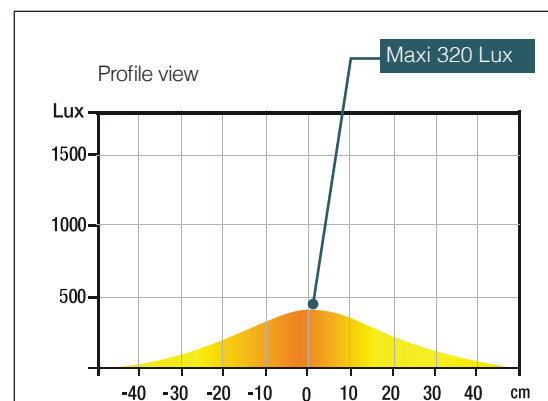

Energy class

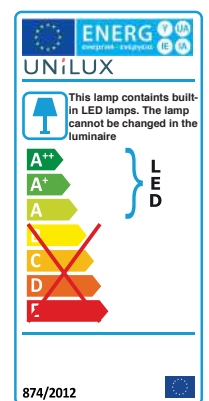





- **Adjustable:** thanks to its adjustable semi-basins, you can adapt your lighting.
- **Easy to use:** Its dimmer on the mast allows you to find the most comfortable lighting for reading, writing and working.
- **Elegant and modern design:** with clean lines and pleasant, this floor lamp of original shape seduce and will adapt perfectly to any type of office.
- **Hygiene:** Equipped with glass, the half basins protect against insects and are easy to clean.
- **Longevity:** the lifetime of its LEDs is estimated at more than 40,000 hours.

- Rated power: this luminaire contains built-in 2x22 W LED lamps that can not be replaced
- Lifetime *: 40,000 hours
- Illumination of 4100 Lux at 55 cm upwards
- Color temperature: 3000 K
- Weighted energy consumption: 36,7 kWh / 1000 h
- Luminous efficiency ** of LEDs: 120 lm / W
- Energy efficiency: class A / A + / A ++ (spectrum A ++ to E)
- CRI: 82
- 2 years warranty
- Height: 184 cm
- Head: Ø 28 cm
- Floor lamp base in stable metal: 5 Kg
- Materials: all high quality steel with epoxy paint finish

* Average consumption: 1000 h / year
 ** Light emission of the lighting source

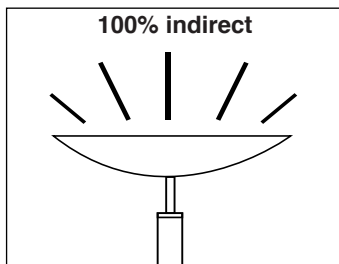

Réf. product	color	Cable length	Code EAN	EA by box
400100711	Metal gray	2,1 m	3595560027002	1 pc.

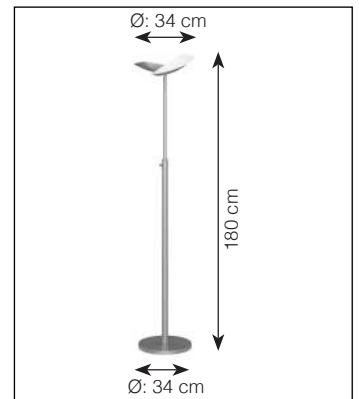

Technical features

Lux measurement upwards at 55 cm from the light source:

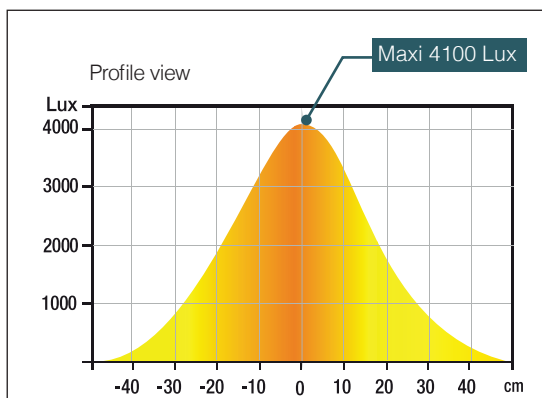

Energy class

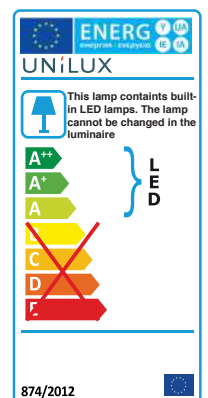

VARIAGLASS LED

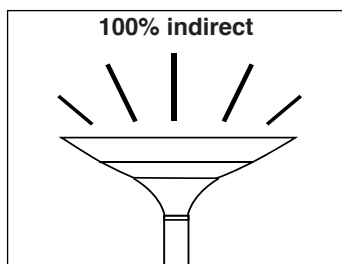

- **Easy to use:** Its dimmer on the mast allows you to find the most comfortable lighting for reading, writing and working.
- **Refined design:** its modern look and its frosted glass basin gives it an elegant character that will harmonize perfectly with your office.
- **Equipped with quality LED (light-emitting diodes):** this floor lamp emits a non-scintillating light and zero radiation, helping to reduce eye strain.
- **Stability:** weighted base of 5 kg, ensures a perfect stability of the lamppost in areas of large passages.
- **Longevity:** the lifetime of its LEDs is estimated at more than 40,000 hours.

Rated power: this luminaire contains integrated LED lamps with a power of 30,7

- W which can not be replaced
- Lifetime *: 40,000 hours
- Illuminance of 2870 Lux at 55 cm upwards
- Color temperature: 3200K
- Weighted energy consumption: 25,6 kWh / 1000 h
- Luminous efficiency ** of LEDs: 120 lm / W
- Energy efficiency: class A / A + / A ++ (spectrum A ++ to E)
- CRI: 82
- 2 years warranty
- Height: 184 cm
- Head: Ø 36 cm
- Variator on mat, height: 119 cm
- Materials: pedestal, high quality steel mast with epoxy paint finish / frosted glass basin

* Average consumption: 1000 h / year
** Light emission of the lighting source

Réf. product	Color	Cable length	Code EAN	EA by box
400090472	Black	1,8 m	3595560014088	1 pc.
400090473	Metal gray	1,8 m	3595560014095	1 pc.

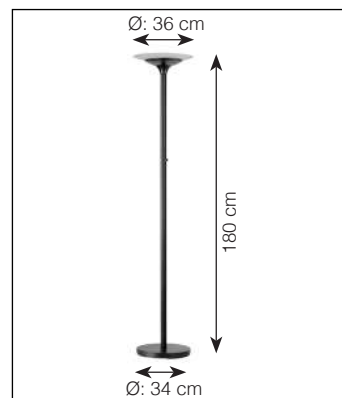

Technical features

Lux measurement upwards at 55 cm from the light source:

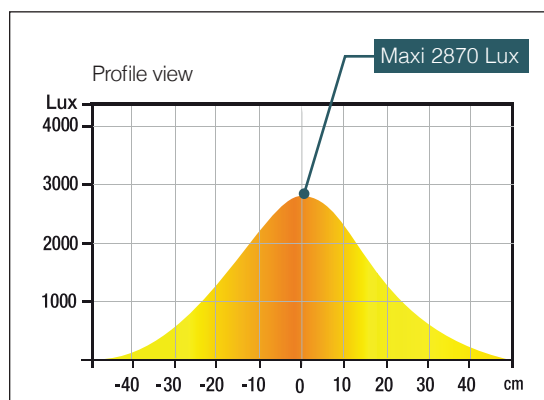

Energy class

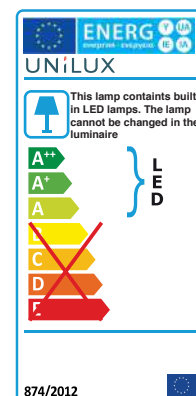

/ PRYSKA



THE + PRODUCT
Dimmer
intensity
tactile

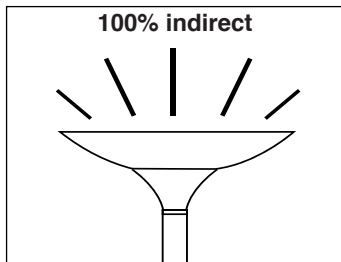

- **Easy to use:** its 3-step touch dimmer located on the mast allows you to find the most comfortable lighting for reading, writing and working.
- **Scandinavian design:** sober and timeless, the wood-white combination sublimates the large interiors such as reception halls as well as the smaller contemporary spaces like contemporary offices.
- **Stability:** weighted base of 5 kg, ensures a perfect stability of the lamppost in areas of large passages.
- **Uniform distribution of light:** indirect lighting without glare, it will better protect your vision for a beneficial work.
- **Longevity:** the lifetime of its LEDs is estimated at more than 40,000 hours.
- **Complementary products:** lamppost perfectly coordinated with the VICKY LED lamp, BALTIC clock, ACCESS coat stand and the ERGO WELL electrical desk.

- Rated power: this luminaire contains integrated LED lamps with a power of 44,6 W which can not be replaced
- Lifetime *: 40,000 hours
- Illumination of 5300 Lux at 55 cm upwards
- Color temperature: 3000 K
- Weighted energy consumption: 37,2 kWh / 1000 h
- Energy efficiency: class A / A + / A ++ (spectrum A ++ to E)
- Luminous efficiency ** of LEDs: 120 Lm / w
- CRI: 83
- 2 years warranty
- Height: 180 cm
- Head: Ø 34 cm
- Floor lamp base in stable metal: 5 Kg
- Materials: high quality steel with Epoxy paint finish and beech wood finish ***

* Average consumption: 1000 h / year
** Light emission of the lighting source
*** Wood from managed eco-friendly forests

Réf. product	Color	Cable length	Code EAN	EA by box
400110157	White/ beech	2,2 m	3595560028047	1 pc.

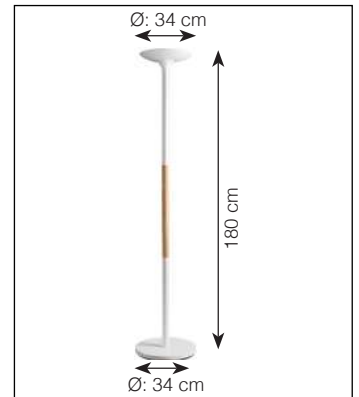

Technical features

LUX measurement upwards at 55 cm from the light source:

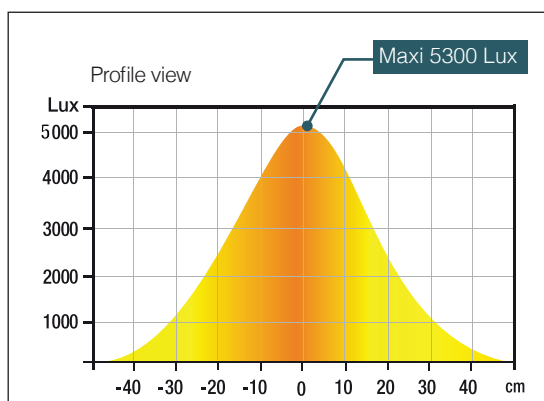

Energy class

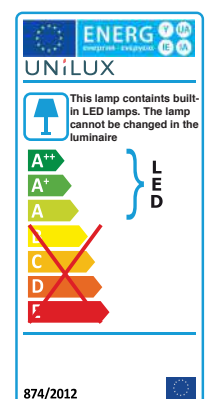

BALTIC: clock Ø: 31.5 cm
silent movement
delivered with its AA1,5V battery
p 124

PRYSKA: LED fuplighter
intensity touch dimmer

VICKY: LED lamp
intensity touch dimmer
USB port
p 49

ERGO WELL: electric desk
3 memory / alarm settings
steel base supports up to 125 Kg
p 105



VARIALUX LED

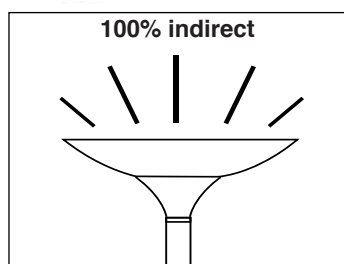

- **Easy to use:** its dimmer on the mast allows you to vary the lighting to suit the activity: reading, writing, work.
- **Contemporary design:** its slender appearance and its enamelled interior basin allows excellent lighting. This floor lamp embellishes and embellishes the workspaces.
- **Longevity:** the lifetime of its LEDs is estimated at more than 40,000 hours.
- **Uniform light distribution:** indirect lighting without glare, you will benefit from high-quality accent lighting.
- **Available in two colors:** black or metal gray

- Rated power: this luminaire contains integrated LED lamps with a power of 29,9 W which can not be replaced
- Lifetime *: 40,000 hours
- Illuminance of 2820 Lux at 55 cm upwards
- Color temperature: 3000 K
- Weighted energy consumption: 24,9 kWh / 1000 h
- Luminous efficiency ** of LEDs: 120 lm / W
- Energy efficiency: class A / A + / A ++ (spectrum A ++ to E)
- CRI: 82
- 2 years warranty
- Height: 180cm
- Head: Ø 28 cm
- Floor lamp base in stable metal: 5 Kg
- Materials: all high quality steel with epoxy paint finish

* Average consumption: 1000 h / year
 ** Light emission of the lighting source

Réf. product	Color	Cable length	Code EAN	EA by box
400090467	Black	2,0 m	3595560014040	1 pc.
400090468	Metal gray	2,0 m	3595560014057	1 pc.

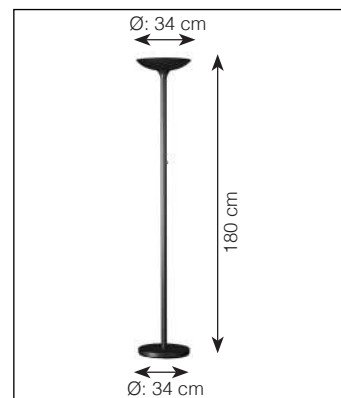

Technical features

Lux measurement upwards at 55 cm from the light source:

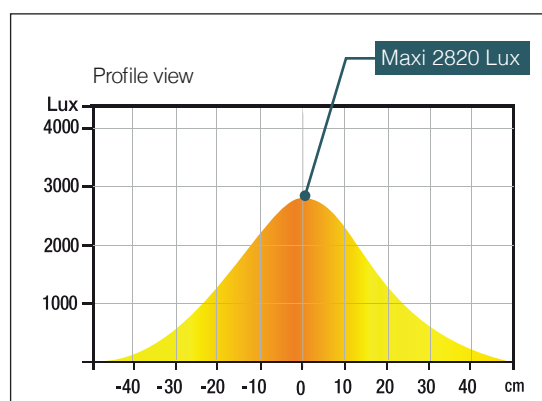

Energy class

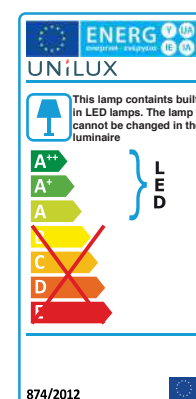

/ VARIALUX LED articulated

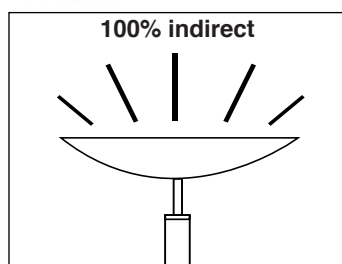

- **Easy to use:** its dimmer on the mast allows you to vary the lighting to suit the activity: reading, writing, work.
- **Contemporary design:** its slender appearance and its enamelled interior basin allows excellent lighting. This floor lamp embellishes and embellishes the workspaces.
- **Longevity:** the lifetime of its LEDs is estimated at more than 40,000 hours.
- **Uniform light distribution:** indirect lighting without glare, you will benefit from high-quality accent lighting.
- **Available in two colors:** black or metal gray

Rated power: this luminaire contains integrated LED lamps with a power of 29,9

- W which can not be replaced
- Lifetime *: 40,000 hours
- Illuminance of 2820 Lux at 55 cm upwards
- Color temperature: 3000 K
- Weighted energy consumption: 24,9 kWh / 1000 h
- Luminous efficiency ** of LEDs: 120 lm / W
- Energy efficiency: class A / A + / A ++ (spectrum A ++ to E)
- CRI: 82
- 2 years warranty
- Max height: 186 cm / min height: 160 cm
- Head: Ø 28 cm
- Floor lamp base in stable metal: 5 Kg
- Materials: all high quality steel with epoxy paint finish

* Average consumption: 1000 h / year
** Light emission of the lighting source

Réf. produit	Color	Cable length	Code EAN	EA by box
400090469	Black articulated	2,0 m	3595560014064	1 pc.
400090471	Metal gray articulated	2,0 m	3595560014071	1 pc.

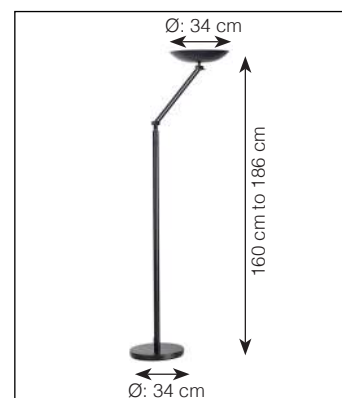

Technical features

Lux measurement upwards at 55 cm from the light source:

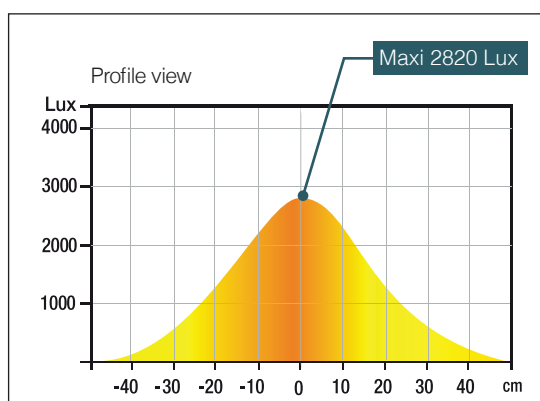

Energy class

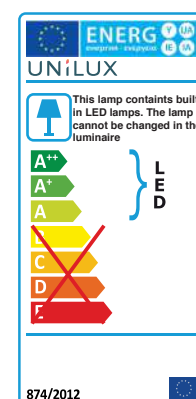



THE + PRODUCT
Dimmer intensity tactile

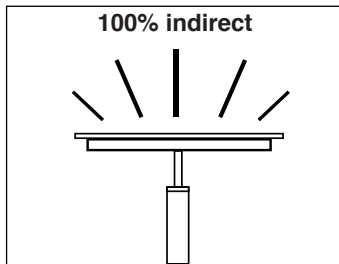

- **Easy to use:** its 3-step touch dimmer located on the mast allows you to find the most comfortable lighting for reading, writing and working.
- **Clean and modern design:** the finesse of its barrel, its sober lines and frosted glass diffuser will bring a light and modern look to your office.
- **Hygiene:** Equipped with a glass, the basin is protected from insects and is easy to clean.
- **Longevity:** the lifetime of its LEDs is estimated at more than 40,000 hours.
- **Uniform distribution of light:** indirect lighting without glare, it will better protect your vision for a beneficial work.

- Rated power: this luminaire contains integrated LED lamps with a power of 29 W that can not be replaced
- Lifetime *: 40,000 hours
- Illuminance of 3160 Lux at 55 cm upwards
- Color temperature: 3000K
- Weighted energy consumption: 24,2 kWh / 1000 h
- Luminous efficiency ** of LEDs: 120 lm / W
- Energy efficiency: class A / A + / A ++ (spectrum A ++ to E)
- CRI: 83
- 2 years warranty
- Height: 180 cm
- Head: Ø 28 cm
- Floor lamp base in stable metal: 2,5 Kg
- Materials: all made of high quality steel with Epoxy paint finish with frosted glass

* Average consumption: 1000 h / year
** Light emission of the lighting source

Réf. product	Color	Cable length	Code EAN	EA by box
400124563	Black	2,25 m	3595560029556	1 pc.

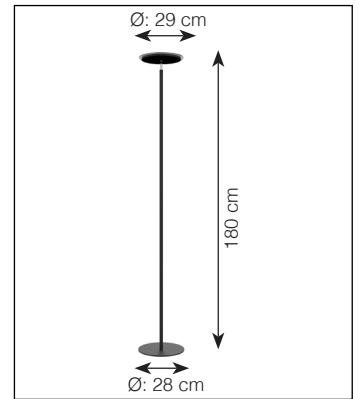

Technical features

Lux measurement upwards at 55 cm from the light source:

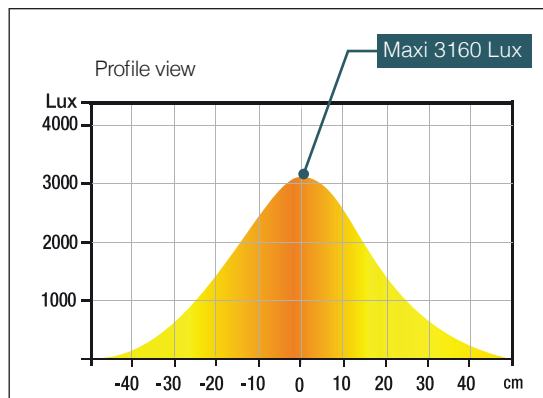

Energy class

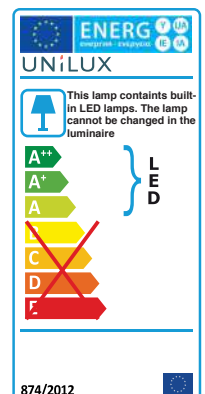



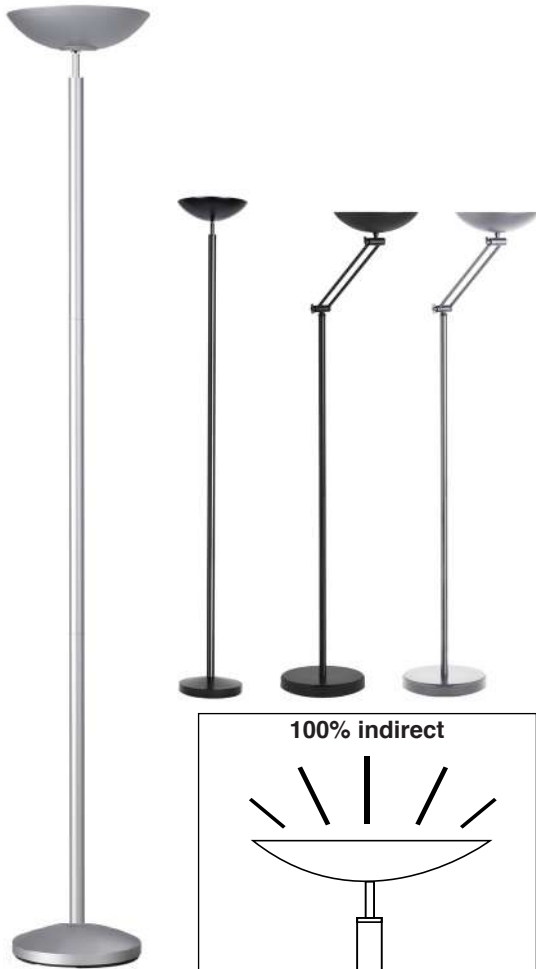

- **Easy to use:** its dimmer on the cord allows you to find the most comfortable lighting for reading, writing and working.
- **Soft and modern design:** its subtlety and sober lines will bring a modern look to your office.
- **Longevity:** the lifetime of its LEDs is estimated at more than 40,000 hours.
- **Uniform light distribution:** indirect lighting without glare, you will benefit from high-quality accent lighting.
- **Available in two colors:** black or metal gray
- **Available in two versions:** straight mast or articulated mast
- Rated power: this luminaire contains integrated LED lamps with a power of 31,9 W that can not be replaced
- Lifetime *: 40,000 hours
- Illuminance of 2870 Lux at 55 cm upwards
- Color temperature: 3100 K
- Weighted energy consumption: 26,6 kWh / 1000 h
- Energy efficiency: class A / A + / A ++ (spectrum A ++ to E)
- Luminous efficiency ** of LEDs: 134 lm / W
- CRI: 81
- 2 years warranty
- Height: 184 cm (right mast version)
- Max height: 186 cm / min height: 160 cm (articulated mast version)
- Head: Ø 28 cm
- Materials: all high quality steel with epoxy paint finish

* Average consumption: 1000 h / year
 ** Light emission of the lighting source

Réf. product	Color	Cable length	Code EAN	EA by box
400050389	Black	1,8 m	3595560008612	1 pc.
400094197	Metal gray	1,8 m	3595560021154	1 pc.
400070582	Articulated black	1,8 m	3595560010905	1 pc.
400094198	Articulated metal gray	1,8 m	3595560021529	1 pc.

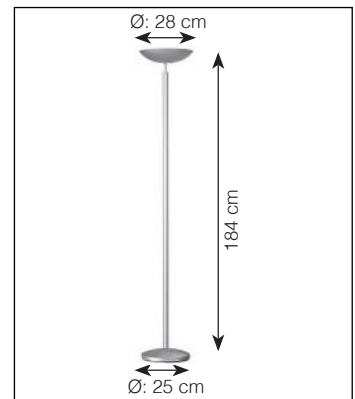

Technical features

Lux measurement upwards at 55 cm from the light source:

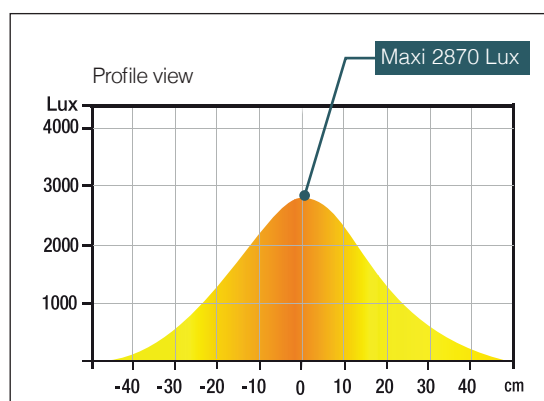

Energy class

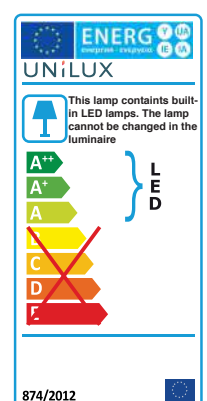

/DELY chrome



- **Easy to use:** its dimmer on the cord allows you to find the most comfortable lighting for reading, writing and working.
- **Soft and modern design:** the subtle lines and high-end chrome finish will bring a modern look to your office.
- **Longevity:** the lifetime of its LEDs is estimated at more than 40,000 hours.
- **Stability:** weighted base of 3 kg, ensures a perfect stability of the lamp post in areas of large passages.
- **Equipped with quality LEDs (light-emitting diodes):** this floor lamp emits a non-scintillating light and zero radiation, helping to reduce eye strain; Low energy consumption helps save energy.

- Rated power: this luminaire contains integrated LED lamps with a power of 31,9 W that can not be replaced
- Lifetime *: 40,000 hours
- Illuminance of 2870 Lux at 55 cm upwards, luminous flux of 3000 Lumens
- Color temperature: 3100 K
- Weighted energy consumption: 26,6 kWh / 1000 h
- Luminous efficiency ** of LEDs: 134 lm / W
- Energy efficiency: class A / A + / A ++ (spectrum A ++ to E)
- CRI: 81
- 2 years warranty
- Height: 184 cm
- Head: Ø 28 cm
- Floor lamp base in stable metal: 3 Kg
- Materials: base, mast and top quality steel head with Epoxy paint finish

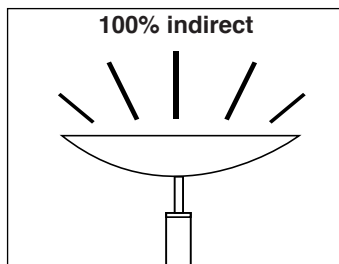

* Average consumption: 1000 h / year
** Light emission of the lighting source

Réf. product	Color	Cable length	Code EAN	EA by box
400069146	Chrome	2,1 m	3595560012053	1 pc.

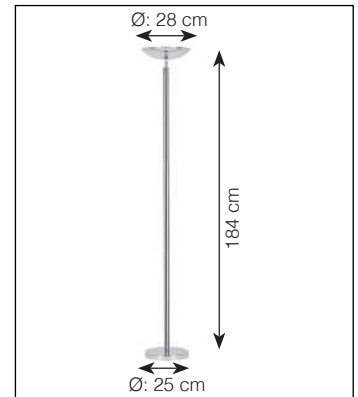

Technical features

Lux measurement upwards at 55 cm from the light source:

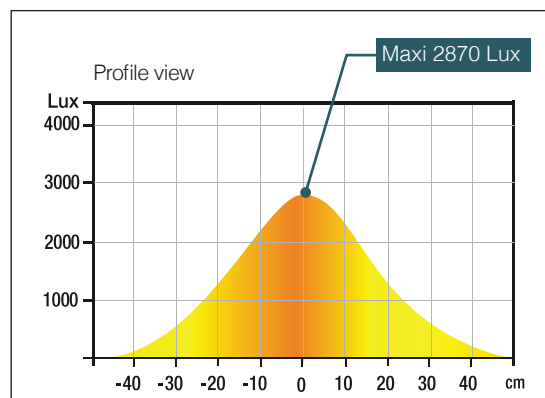

Energy class

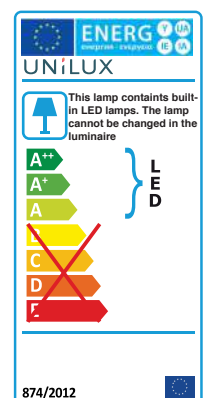

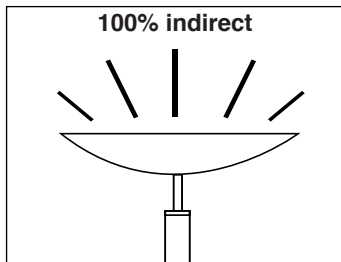
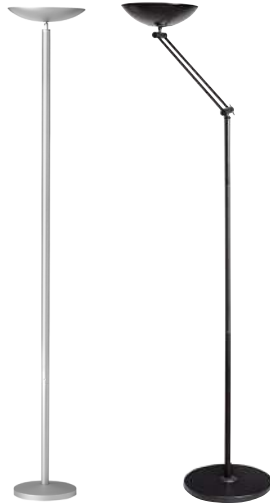
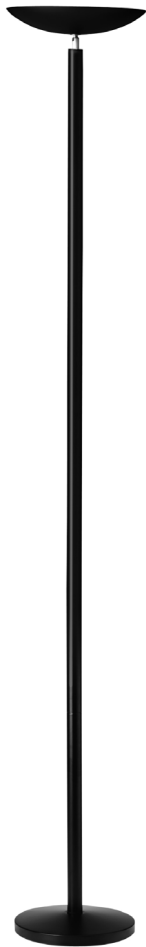

- **Easy to use:** its dimmer on the cord allows you to find the most comfortable lighting for reading, writing and working.
- **Soft and modern design:** its subtlety and sober lines will bring a modern look to your office.
- **Stability:** its weighted base ensures perfect stability of the lamppost in areas of large passages.
- **Uniform distribution of light:** indirect lighting without glare.
- **Available in two colors:** black or gray metal
- **Available in two versions:** straight mast or articulated mast

- Nominal power: this luminaire is supplied with a halogen tube 230W RS7
- Lifetime *: 2.000 hours
- Illuminance of 2800 Lux at 55 cm upwards
- Color temperature: 3000 K
- Weighted energy consumption: 197,5 kWh / 1000 h
- Energy efficiency: class C (spectrum A ++ to E)
- CRI: 99
- 2 years warranty
- Height: 184 cm (right mast version)
- Max height: 180 cm / min height: 160 cm (articulated mast version)
- Head: Ø 28 cm
- Floor lamp base in stable metal: 2 Kg
- Materials: base, mast and top quality steel head with Epoxy paint finish

* Average consumption: 1000 h / year

Réf. product	Color	Cable length	Code EAN	EA by box
100340557	Black	2,1 m	3595560007240	1 pc.
100340559	Metal gray	2,1	3595560006595	1 pc.
100340570	Articulated black	2,1m	3595560008421	1 pc.

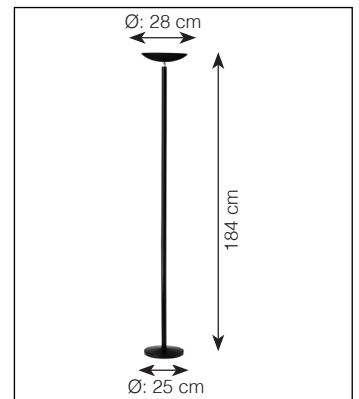

Technical features

Lux measurement upwards at 55 cm from the light source:

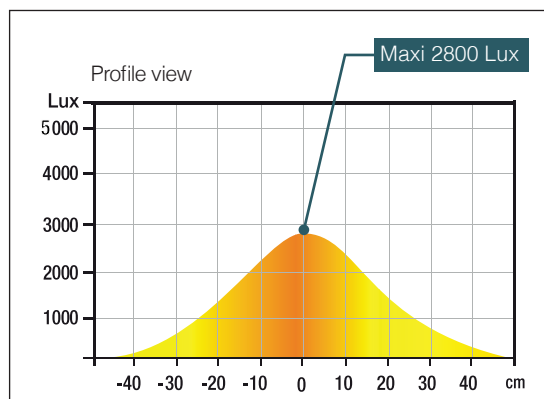

Energy class

ENERGY LABEL UNiLUX

This luminaire is supplied with a 230W RS7 halogen tube

A++
A+
A
B
C
D
E

C

874/2012

/ CRISTALIA



- **Easy to use:** its dimmer on the cord allows you to find the most comfortable lighting for reading, writing and working.
- **Soft and modern design:** its subtlety and sober lines will bring a modern look to your office.
- **Stability:** weighted base of 6kg, ensures a perfect stability of the lamp post in areas of large passages.
- **Uniform distribution of light:** indirect lighting without glare.

- Nominal power: this luminaire is supplied with a halogen tube 230W RS7
- Lifetime *: 2.000 hours
- Illumination of 2800 Lux at 55 cm upward
- Color temperature: 3000 K
- Weighted energy consumption: 197.5 kWh / 1000 h
- Energy efficiency: class C (spectrum A ++ to E)
- CRI: 99
- 2 years warranty
- Height: 184 cm
- Head: 41 cm x 21 cm
- Floor lamp base in stable metal: 6 Kg
- Materials: base and mast in steel / head with chrome steel trim and frosted glass

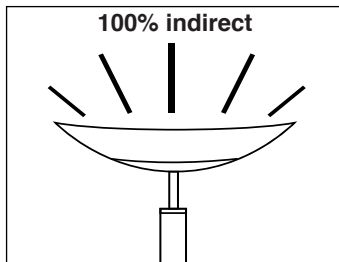

* Average consumption: 1000 h / year

Réf. product	Color	Cable length	Code EAN	EA by box
100340573	Metal gray	2,1 m	3595560006601	1 pc.

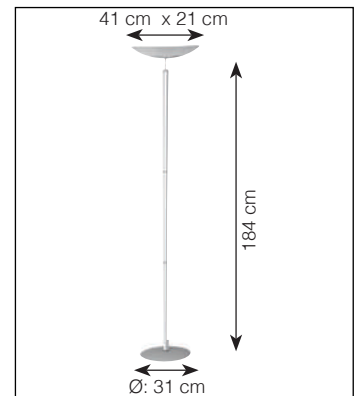

Technical features

Lux measurement upwards at 55 cm from the light source:

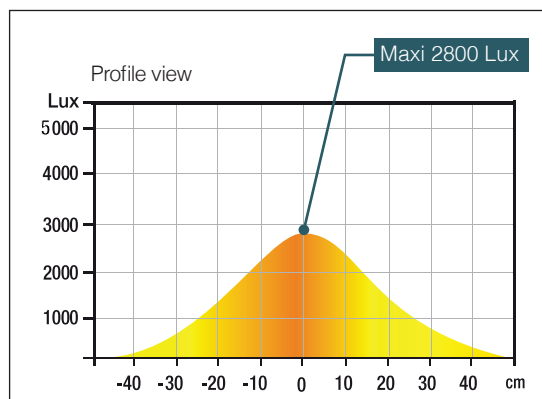

Energy class

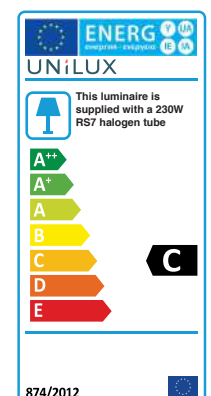

TIMELIGHT



- **Well-being:** innovative and connected lamp via your smartphone that synchronizes your circadian rhythm by reproducing sunlight and its impact on hormones (melatonin and serotonin).
 - **Automatic mode:** The pre-programmed circadian cycle brings you the right quality of light at the right time of day.
 - **Manual mode:** adjustment of intensity and color temperature according to your needs.
 - **Wireless induction charging socket (5 W):** Charge your smartphone or other compatible* device by simply placing it on the lamp base.
 - **USB charging port:** integrated USB 2.0 Type A connection 5 V, max. 1A, charge your smartphone or tablet (cable not supplied).
 - **Innovative design:** this slender and aerial design lamp can be assembled and disassembled in a few seconds thanks to its innovative connectivity.
 - **Convenient to use:** The intensity dimmer is fully adjustable, just touch the touch button to adjust the light.
 - **Low visual stress after prolonged use:** ideal for working, reading or studying, at home or in the office.
- Rated power: this luminaire contains built-in LED lamps with a power of 9 W that can not be replaced
 - Lifetime* of LEDs: 50,000 hours
 - Illumination of 1450 Lux at 35 cm
 - Color temperature: 2700 K to 5200 K
 - Weighted energy consumption: 7,5 kWh / 1000 h
 - Luminous efficiency ** of LEDs: 100 lm / W
 - Energy efficiency: class A / A + / A ++ (spectrum A ++ to E)
 - CRI: 82
 - 2 years warranty
 - Max height: 50 cm
 - Materials: ABS plastic base and head/ aluminum arm

* Average consumption: 1000 h / year
 ** Light emission of the lighting source

Réf. product	Color	Cable length	Code EAN	EA by box
400110241	Black	1,8 m	3595560028085	1 pc.

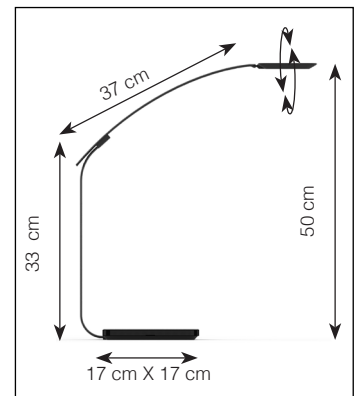

Technical features

Measurement of Lux on the worktop in 35 cm top view:

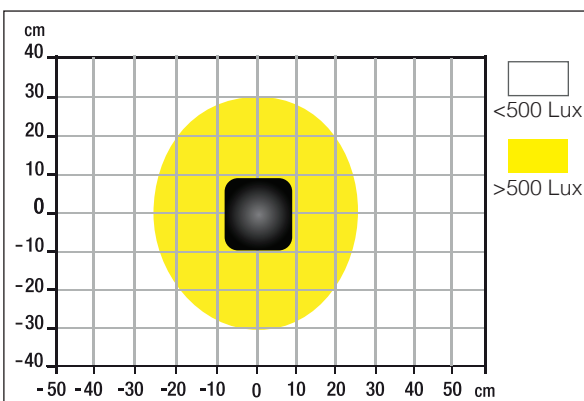

Measurement of Lux on the worktop with a 35 cm profile:

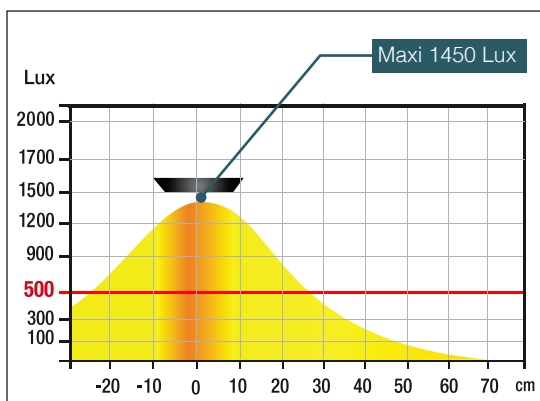

Energy class

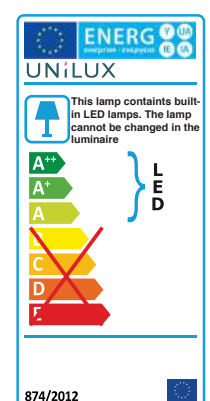

/CONNECTED LAMPS



Biodynamic lighting: source of well-being!

The light acts on the phases of watch and sleep, thus maintaining the circadian rhythm: the active phase starts as soon as the day gets up and the rest phase as soon as the night falls. Lighting plays a key role **in improving concentration, creativity and performance**, thanks to the regulation of melatonin (the hormone of falling asleep).

It is in fact at **480 nanometers** precisely that the light perceived by the receivers of the human eye, will lower the rate of melatonin and that the person will benefit from **the stimulating and soothing effects of light**.

It is in this so-called "human centric lighting" approach, that UNILUX has designed its range of connected lamps (SUNLIGHT, EYELIGHT and TIMELIGHT) which reproduce a light close to natural light by playing in particular on the automatic control of the temperature of color throughout the day by programming 3 essential steps of your day: arrival at work in the morning, lunch break, end of the day.

These exceptional lamps bring good quality of light at every moment of the day.

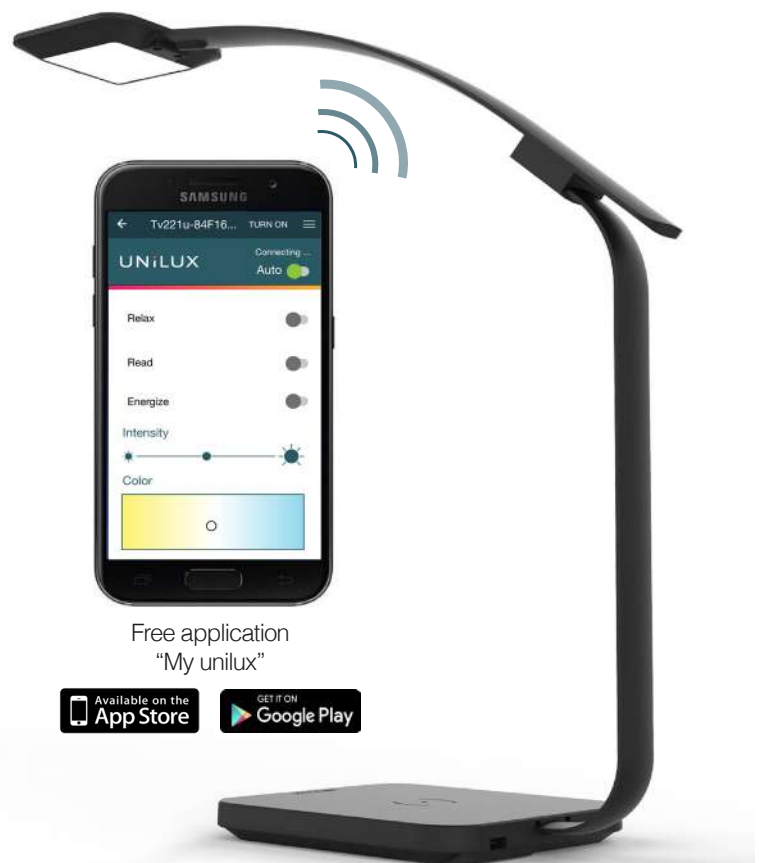

Free application
"My unilux"



/ EYELIGHT



- **Well-being:** innovative and connected lamp via your smartphone that synchronizes your circadian rhythm by reproducing sunlight and its impact on hormones (melatonin and serotonin).
- **Automatic mode:** The pre-programmed circadian cycle brings you the right quality of light at the right time of day.
- **Manual mode:** adjustment of intensity and color temperature according to your needs.
- **Convenient to use:** the intensity is fully adjustable, simply touch the touch button under the head to adjust the intensity of the light.
- **Trendy and functional design:** its slender and dynamic lines will seduce a large number of users.
- **Low visual stress after prolonged use:** ideal for working, reading or studying, at home or in the office.
- **Available in two colors:** black or gray metal

- Rated power: this luminaire contains built-in LED lamps with a power of 9 W that can not be replaced
- Lifetime * of LEDs: 50,000 hours
- Illumination of 1950 Lux at 35 cm
- Color temperature: 2700 K to 5200 K
- Weighted energy consumption: 7,5 kWh / 1000 h
- Luminous efficiency ** of LEDs: 100 lm / W
- Energy efficiency: class A / A + / A ++ (spectrum A ++ to E)
- CRI: 82
- 2 years warranty
- Maximum height: 48 cm / minimum height: 37 cm
- Materials: ABS plastic base / aluminum arm and head

* Average consumption: 1000 h / year
 ** Light emission of the lighting source

Réf. product	Color	Cable length	Code EAN	EA by box
400093835	Black	3,0 m	3595560015672	1 pc.
400095547	Metal gray	3,0 m	3595560026005	1 pc.

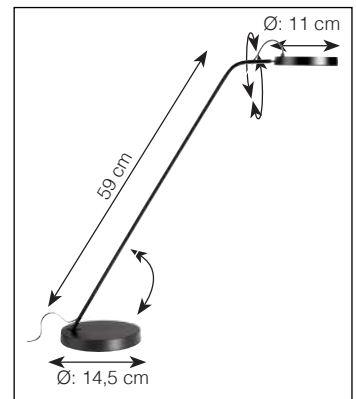

Technical features

Measurement of Lux on the worktop in 35 cm top view:

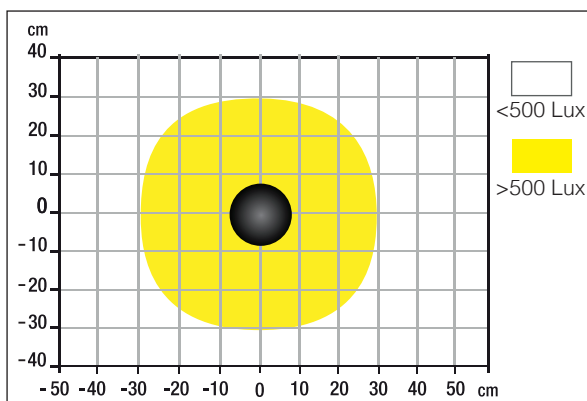

Measurement of Lux on the worktop with a 35 cm profile:

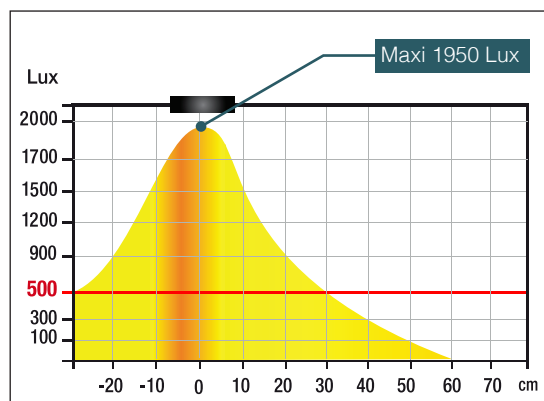

Energy class

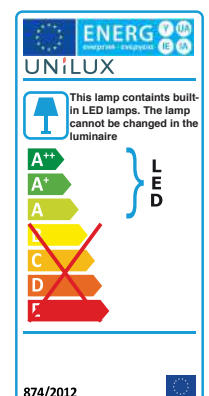

/ SUNLIGHT



- **Well-being:** innovative and connected lamp via your smartphone that synchronizes your circadian rhythm by reproducing sunlight and its impact on hormones (melatonin and serotonin).
- **Automatic mode:** The pre-programmed circadian cycle brings you the right quality of light at the right time of day.
- **Manual mode:** adjustment of intensity and color temperature according to your needs.
- **Contemporary design:** the worked design of the head and the fineness of the arm give a pure and original line to the lamp. It fits both in the office and at home.
- **Optimal and even light diffusion:** thanks to its LED with natural lighting, this lamp will better protect your vision, reduce the tension and fatigue of your eyes.
- **ON / OFF switch:** located on the easy access cord.

- Rated power: this luminaire contains built-in LED lamps with a power of 9 W that can not be replaced
- Lifetime * of LEDs: 50,000 hours
- Illumination of 1480 Lux at 35 cm
- Color temperature: 2700 K to 5200 K
- Weighted energy consumption: 7,5 kWh / 1000 h
- Luminous efficiency ** of LEDs: 100 lm / W
- Energy efficiency: class A / A + / A ++ (spectrum A ++ to E)
- CRI: 82
- 2 years warranty
- Max height: 50 cm
- Materials: pedestal and head in high quality steel with epoxy paint / chromed steel arm

* Average consumption: 1000 h / year
 ** Light emission of the lighting source

Réf. product	Color	Cable length	Code EAN	EA by box
400110128	Black/ chrome	1,9 m	3595560028030	1 pc.

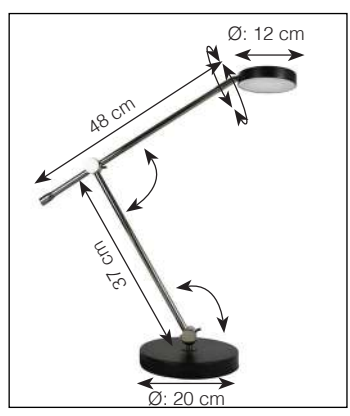

Technical features

Measurement of Lux on the worktop in 35 cm top view:

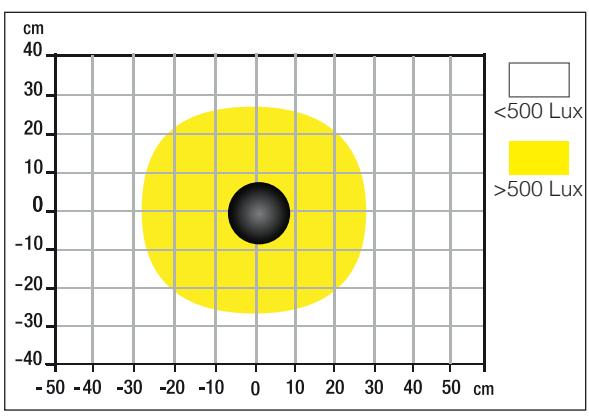

Measurement of Lux on the worktop with a 35 cm profile:

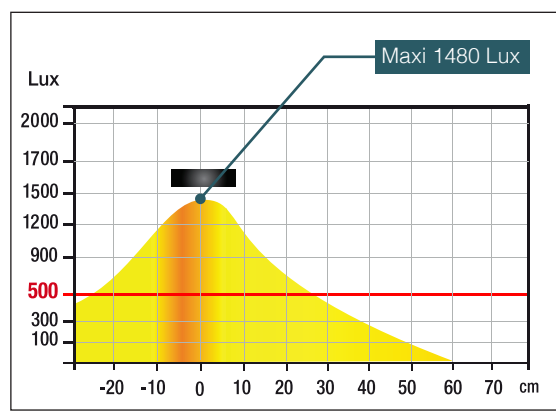

Energy class

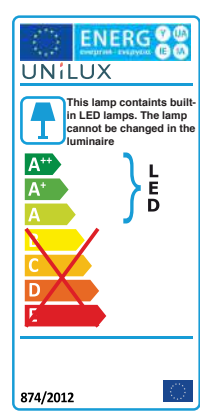

STRATA



THE + PRODUCT
With
lighting
sensor

- **Asymmetrical lighting:** equipped with asymmetric lighting that neutralizes much of the glare and greatly increases the area illuminated. **Innovation:** a new generation of ergonomic desk lamp that offers great light amplitude, quality custom lighting and reduces eye strain.
- **Optimum visual comfort:** thanks to its flexible arm STRATA adapts to the height and size of your screens.
- **Modern design lamp:** its innovative, slender, airy and refined design will sublimate your office interior.
- **Variation of light intensity and color temperature:** on its head, two touch switches allow to vary the light intensity and another to adjust the color temperature. Adapt your lighting according to your activity (rest, reading, work).
- **Intelligent:** depending on the ambient light of your workspace, the lamp adapts its light for a better visual comfort, thanks to its brightness sensor

- Rated power: this luminaire contains integrated LED lamps with a power of 12,7 W that can not be replaced
- Lifespan * of LEDs: 50,000 hours
- Illuminance of 1170 Lux at 50 cm
- Color temperature: 3000 K to 6000 K
- Weighted energy consumption: 10,6 kWh / 1000 h
- Luminous efficiency ** of LEDs: 100 lm / W
- Energy efficiency: class A / A + / A ++ (spectrum A ++ to E)
- CRI: 82
- 2 years warranty
- Maximum height: 70 cm / minimum height: 50 cm
- Materials: high quality steel clamp (maximum spacing 8 cm) / aluminum arm and rubber-coated metal / aluminum head

* Average consumption: 1000 h / year
** Light emission of the lighting source

Réf. product	Color	Cable length	Code EAN	EA by box
400124562	Black	2,0 m	3595560029525	1 pc.

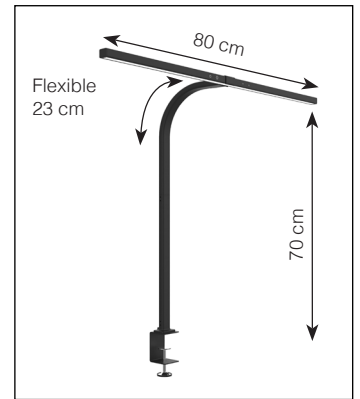

Technical features

Measurement of Lux on the worktop in 50 cm top view:

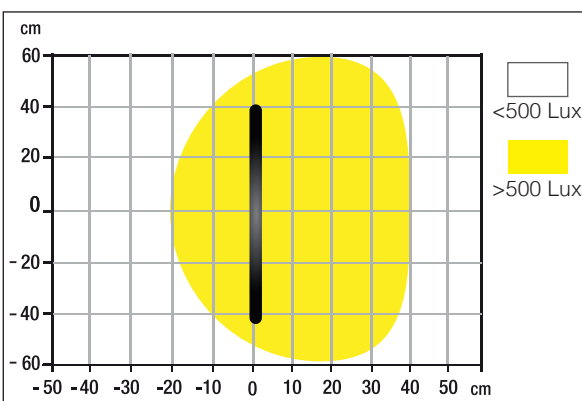

Measurement of Lux on the worktop with a 50 cm profile:

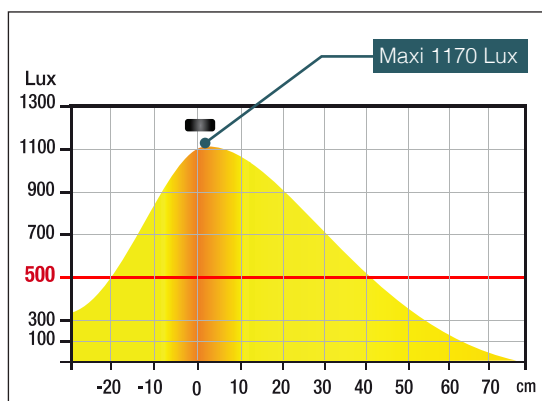

Energy class

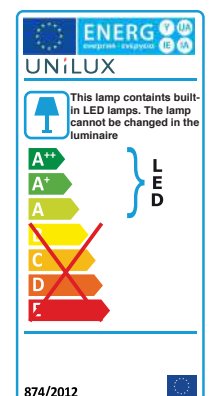

/ DESIGN LAMPS



/ DUO LED



- **Adjustment:** amplitude and flexibility thanks to its arm pivoting at 90 ° on the base and its large profiled head that can be swiveled in all directions allows a wide spectrum of light diffusion on your worktop.
- **Contemporary design:** with its dynamic and modern lines, this lamp allows an optimal diffusion of the light on the worktop. It fits perfectly to all office sizes.
- **Office lamp using the latest generation LED, saving energy:** it has a lifetime of 50 000 h.
- **Flicker-free light:** provides a powerful and comfortable light that protects your eyes and causes less fatigue.
- **Complementary:** lamp perfectly coordinated with UNILUX office accessories (clocks, coat hangers, footrests, ergonomic products).

- Rated power: this luminaire contains integrated LED lamps with a power of 9,4 W which can not be replaced
- Lifetime* of LEDs: 50,000 hours
- Illumination of 810 Lux at 35 cm
- Color temperature: 3400 K
- Weighted energy consumption: 7,8 kWh / 1000 h
- Luminous efficiency ** of LEDs: 100 lm / W
- Energy efficiency: class A / A + / A ++ (spectrum A ++ to E)
- CRI: 81
- 2 years warranty
- Maximum height: 60 cm / minimum height: 32 cm
- Materials: epoxy painted steel base / santoprene arm and recyclable aluminum / ABS plastic head

* Average consumption: 1000 h / year

** Light emission of the lighting source

Réf. product	Color	Cable length	Code EAN	EA by box
400093984	Black	2,7 m	3595560020874	1 pc.

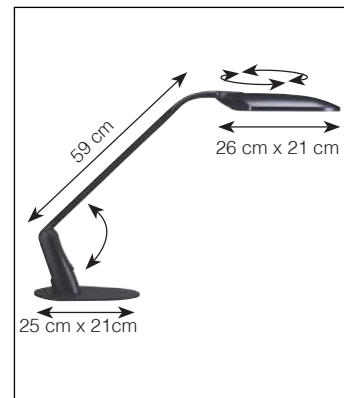

Technical features

Measurement of LUX on the worktop in 35 cm top view:

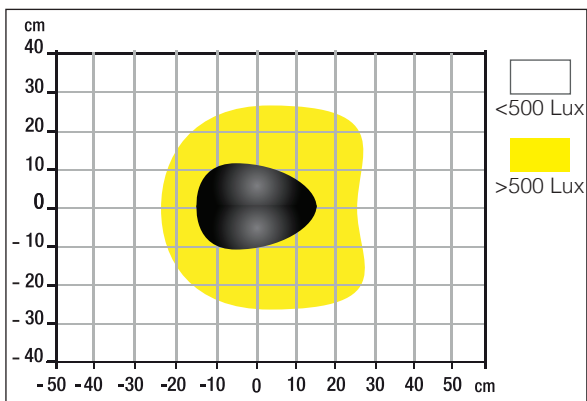

Measurement of LUX on the worktop with a 35 cm profile:

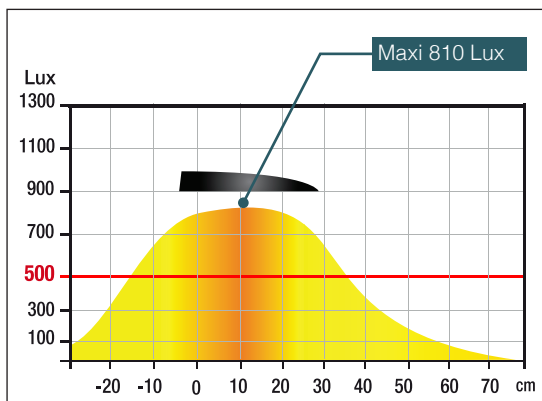

Energy class

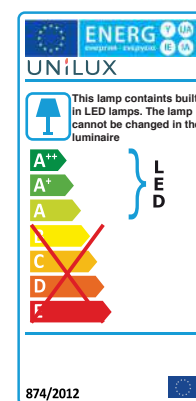

/ SENSATION



- **Asymmetrical lighting:** equipped with asymmetric lighting that neutralizes much of the glare and greatly increases the area illuminated.
- **Convenient to use:** the intensity is fully adjustable, just touch the touch button to adjust the light.
- **Smart:** The memory feature allows you to adjust the brightness once, it will automatically return to your setting when you turn it back on.
- **Flexible and adjustable:** the lamp is oriented in all directions thanks to its flexible double joint (high and low) which facilitates its use, and its asymmetric lighting allows a wide diffusion of light on the work surface.
- **Ecological and efficient lighting:** its powerful LED allow lighting up to 40 000h. An automatic shutdown system is done after 15 minutes if no motion is detected.
- **Take care of your eyes:** latest generation LED lighting, high quality, uniform, without flickering and glare. It has no harmful radiation to the eyes avoiding eyestrain.

- Rated power: this luminaire contains integrated LED lamps with a power of 8,2 W which can not be replaced
- Lifetime * of LEDs: 40,000 hours
- Illumination of 1285 Lux at 40 cm
- Color temperature: 3000 K
- Weighted energy consumption: 6,8 kWh / 1000 h
- Luminous efficiency ** of LEDs: 100 lm / W
- Energy efficiency: class A / A + / A ++ (spectrum A ++ to E)
- CRI: 82
- 2 years warranty
- Maximum height: 52 cm / minimum height: 38 cm
- Materials: base and head in ABS plastic / metal arm with rubber surface

* Average consumption: 1000 h / year

** Light emission of the lighting source

Réf. product	Color	Cable length	Code EAN	EA by box
100340449	Black	2,0 m	3595560015573	1 pc.

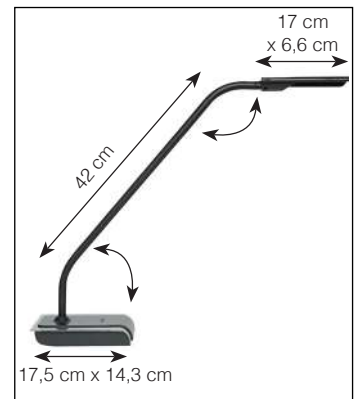

Technical features

Measurement of Lux on the worktop in 40 cm top view:

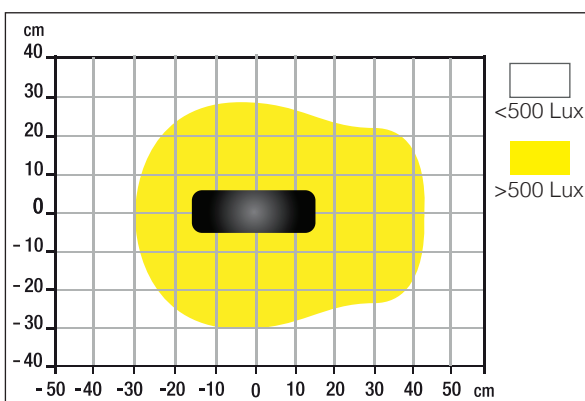

Measurement of Lux on the worktop with a 40 cm profile:

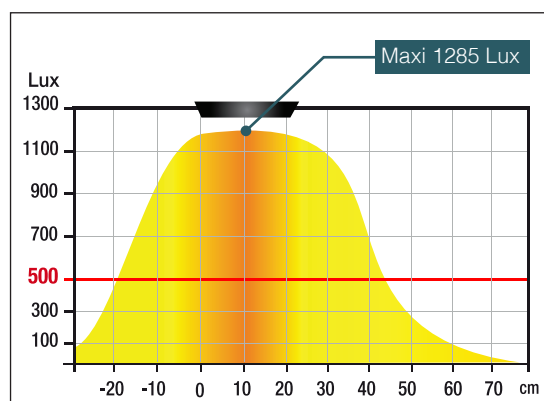

Energy class

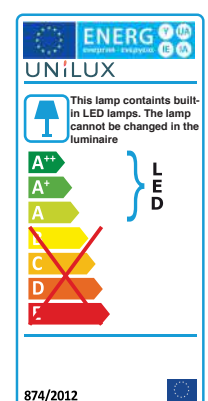

/ ERGOLIGHT



- **Asymmetrical lighting:** equipped with asymmetric lighting that neutralizes much of the glare and greatly increases the area illuminated.
 - **Convenient to use:** The dimmer is fully adjustable, just touch the touch button to adjust the light.
 - **Smart:** The memory feature allows you to adjust the brightness once, it will automatically return to your setting when you turn it back on.
 - **Ecological lighting:** an automatic shutdown system is done after 15min if no movement is detected.
 - **Modern and practical design:** Made from recyclable aluminum, this lamp fits directly behind the computer screen. It will fit perfectly to any screen size and any type of office.
 - **Adjustable adjustment:** its height-adjustable arm, pivoting on the base and its rectangular head adjustable multidirectional front-rear, allows optimal distribution of light on the worktop.
 - **Energetically efficient:** this lamp consumes 75% less energy than incandescent lighting and 35% less energy than fluorescent lighting for the same level of brightness: lifetime: 40,000 hours.
- Rated power: this luminaire contains built-in LED lamps with a power of 9,6 W which can not be replaced
 - Lifetime * of LEDs: 40,000 hours
 - Illumination of 840 Lux at 40 cm
 - Color temperature: 3000 K
 - Weighted energy consumption: 8 kWh / 1000 h
 - Luminous efficiency ** of LEDs: 100 lm / W
 - Energy efficiency: class A / A + / A ++ (spectrum A ++ to E)
 - CRI: 83
 - 2 years warranty
 - Maximum height: 51 cm / minimum height: 38 cm
 - Materials: steel base / aluminum arm / ABS plastic head

* Average consumption: 1000 h / year
 ** Light emission of the lighting source

Réf. product	Colour	Cable length	Code EAN	EA by box
100340991	Black	2,8 m	3595560021062	1 pc.

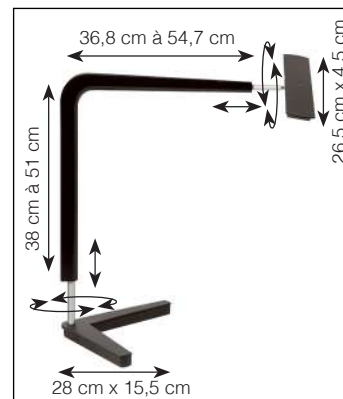

Technical features

Measurement of Lux on the worktop in 40 cm top view:

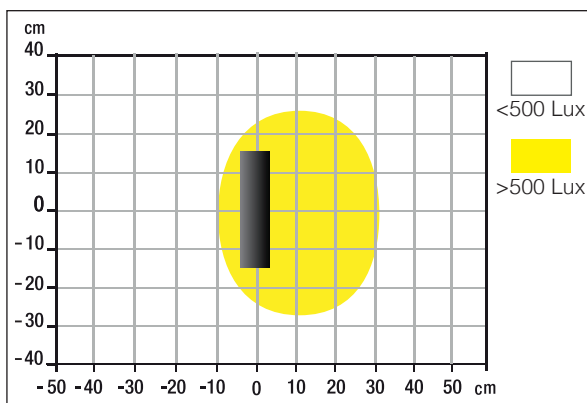

Measurement of Lux on the worktop with a 40 cm profile:

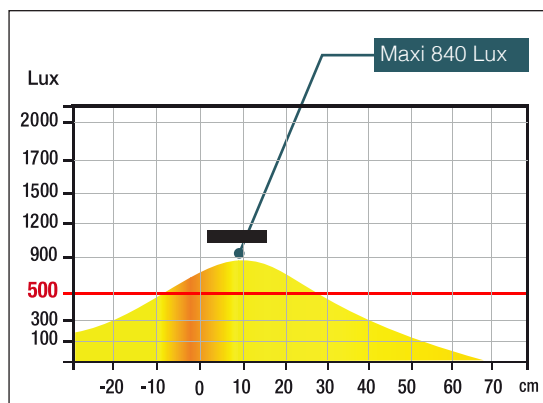

Energy class

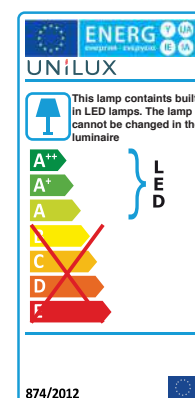

/ FOLIA



- **Asymmetrical lighting:** equipped with asymmetric lighting that neutralizes much of the glare and greatly increases the area illuminated.
- **Design:** its graceful and airy lines give it a lot of lightness. It will bring charm to your desk.
- **Ecological lighting:** an automatic shutdown system is done after 5 hours of use.
- **Convenient to use:** The intensity dimmer is fully adjustable, just touch the touch button to adjust the light.
- **Low visual stress after prolonged use:** ideal for working, reading or studying, at home or in the office.
- **Office lamp using the latest generation LED, saving energy:** it has a lifetime of 40 000h. Save money.
- **Available in two colours:** black or white / grey metal

- Rated power: this luminaire contains built-in LED lamps with a power of 9,4 W which can not be replaced
- Lifetime * of LEDs: 40,000 hours
- Illumination of 1480 Lux at 35 cm
- Color temperature: 3000K
- Weighted energy consumption: 7,8 kWh / 1000 h
- Luminous efficiency ** of LEDs: 100 lm / W
- Energy efficiency: class A / A + / A ++ (spectrum A ++ to E)
- CRI: 84
- 2 years warranty
- Maximum height: 62 cm / minimum height: 32 cm
- Materials: head and base in ABS plastic / aluminum arm

* Average consumption: 1000 h / year
 ** Light emission of the lighting source

Réf. product	Color	Cable length	Code EAN	EA by box
400020346	Black	2,0 m	3595560002856	1 pc.
100340438	White	2,0 m	3595560016174	1 pc.



Technical features

Measurement of Lux on the worktop in 35 cm top view:

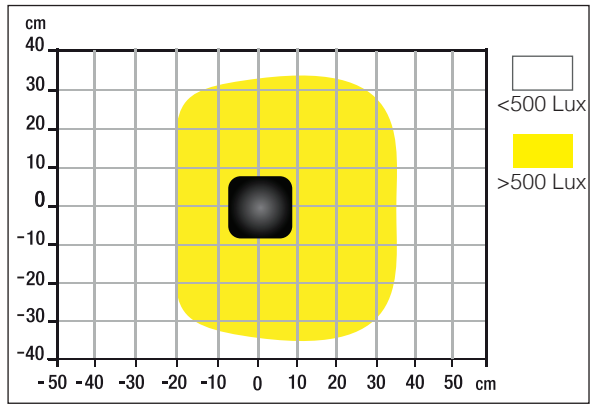

Measurement of Lux on the worktop with a 35 cm profile:

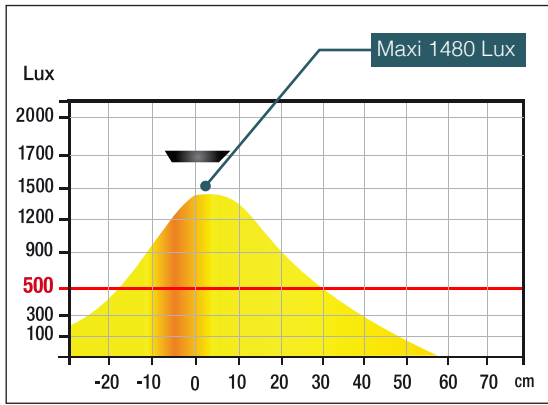

Energy class

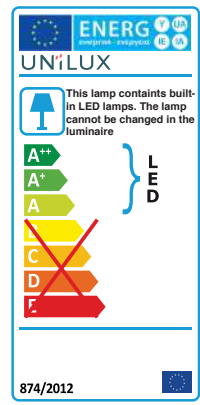



- **Convenient to use:** The intensity dimmer is fully adjustable, just touch the touch button to adjust the light.
- **Smart:** The memory feature allows you to adjust the brightness once, it will automatically return to your setting when you turn it back on.
- **Trendy and functional design:** its slender and dynamic lines will seduce a large number of users
- **Optimal and constant light distribution:** its natural LED lighting will better protect your vision and reduce tension and fatigue.
- **Low visual stress after prolonged use:** ideal for working, reading or studying, at home or in the office.
- **Complementary:** lamp perfectly coordinated with UNILUX office accessories (clocks, coat hangers, footrests, ergonomic products).

- Rated power: this luminaire contains built-in LED lamps with a power of 9,1 W that can not be replaced
- Lifetime * of LEDs: 40,000 hours
- Illumination of 1410 Lux at 35 cm
- Color temperature: 3650 K
- Weighted energy consumption: 7,6 kWh / 1000 h
- Luminous efficiency ** of LEDs: 100 lm / W
- Energy efficiency: class A / A + / A ++ (spectrum A ++ to E)
- CRI: 86
- 2 years warranty
- Maximum height: 48 cm / minimum height: 37 cm
- Materials: ABS plastic base / arms and aluminum epoxy finish

* Average consumption: 1000 h / year
 ** Light emission of the lighting source

Réf. product	Color	Cable length	Code EAN	EA by box
400036264	Black	3,0 m	3595560006519	1 pc.

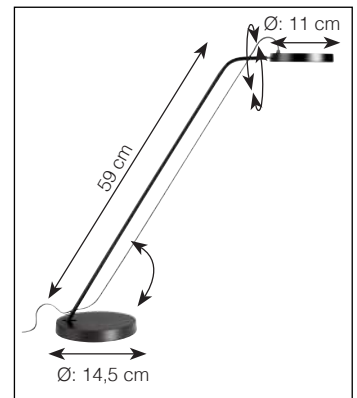

Technical features

Measurement of Lux on the worktop in 35 cm top view:

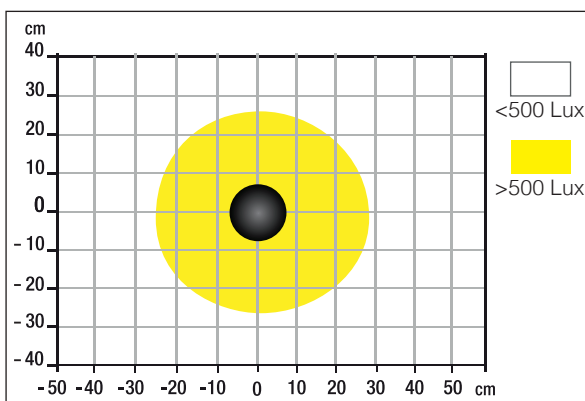

Measurement of Lux on the worktop with a 35 cm profile:

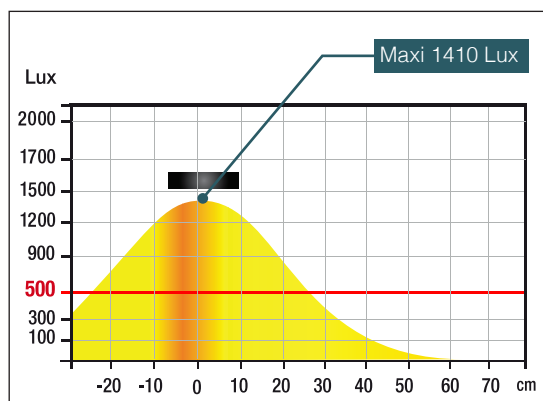

Energy class

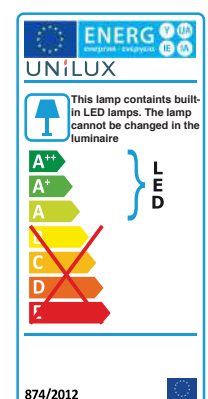

/ BRIO 2



- **Lighting:** its elongated head allows optimal light diffusion on the worktop.
 - **Adjustment:** arm with a double high and low articulation allowing optimal adjustment of the product.
 - **Contemporary design:** with its dynamic and modern lines, this lamp fits perfectly to all office sizes.
 - **Comfortable light for the eyes:** with its latest generation LED, the light is stable without flickering or glare. Protects your eyes well
 - **Office lamp using the latest generation LED, saving energy:** it has a lifetime of 50 000h.
- Rated power: this luminaire contains built-in LED lamps with a power of 7 W which can not be replaced
 - Lifetime * of LEDs: 50,000 hours
 - Illumination of 1830 Lux at 35 cm
 - Color temperature: 3500 K
 - Weighted energy consumption: 5,8 kWh / 1000 h
 - Luminous efficiency ** of LEDs: 130 lm / W
 - Energy efficiency class A / A + / A ++ (spectrum A ++ to E)
 - CRI: 82
 - 2 years warranty
 - Maximum height: 57 cm / minimum height: 25 cm
 - Materials: ABS plastic base, arm and head

* Average consumption: 1000 h / year
 ** Light emission of the lighting source

Réf. product	Color	Cable length	Code EAN	EA by box
400093669	Black	2,0 m	3595560014736	1 pc.

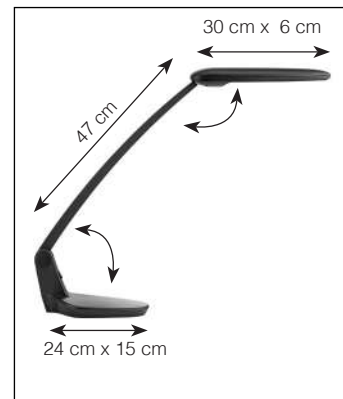

Technical features

Measurement of Lux on the worktop in 35 cm top view:

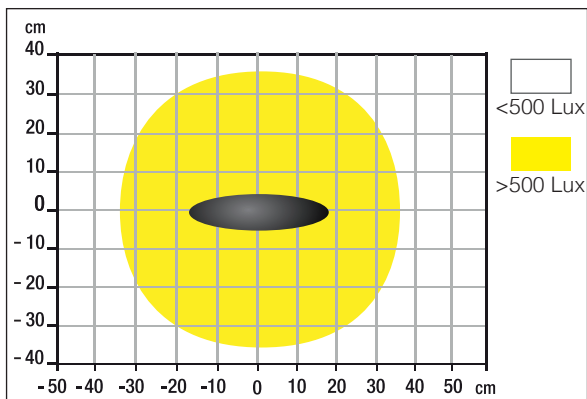

Measurement of Lux on the worktop with a 35 cm profile:

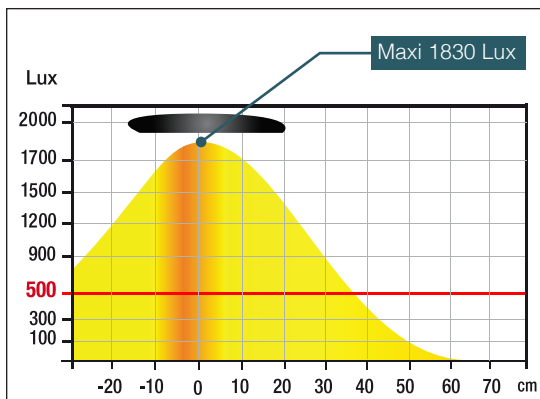

Energy class

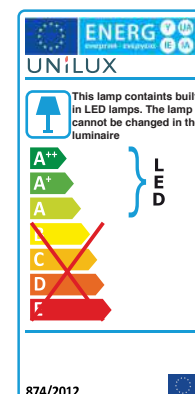

/ JOKER LED



- **Its ON / OFF switch:** easy to access, it is located on the base. With the 2 dimming positions, choose the most appropriate light intensity throughout the day to better meet your needs.
- **Best-seller:** modern design combining rounded shapes and harmonious proportions. An essential model that will adapt perfectly to any type of office.
- **Energetically efficient:** this lamp consumes 75% less energy than incandescent lighting and 35% less energy than fluorescent lighting for the same level of brightness. Life time: 40 000h.
- **A pleasant light, equipped with a technology protecting your eyes:** a stable and quality light thanks to the latest generation LEDs. In addition, LEDs are protected by an opaque plastic: neither flicker nor glare.
- **Interchangeable LED Module:** The user can change the LEDs as easily as a light bulb.

- Rated power: this luminaire contains integrated LED lamps with a power of 6,6 W
- Lifetime * of LEDs: 40,000 hours
- Illumination of 1760 Lux at 35 cm
- Color temperature: 3000 K
- Weighted energy consumption: 5,5 kWh / 1000 h
- Luminous efficiency ** of LEDs: 130 lm / W
- Energy efficiency: class A / A + / A ++ (spectrum A ++ to E)
- CRI: 92
- 2 years warranty
- Maximum height: 50 cm / minimum height: 30 cm
- Materials: ABS plastic base and head / epoxy finish aluminum arm

* Average consumption: 1000 h / year
 ** Light emission of the lighting source

Réf. product	Color	Cable length	Code EAN	EA by box
400064432	Black	2,0 m	3595560011353	1 pc.
400064434	Metal gray	2,0 m	3595560011377	1 pc.
400064436	Purple	2,0 m	3595560011384	1 pc.

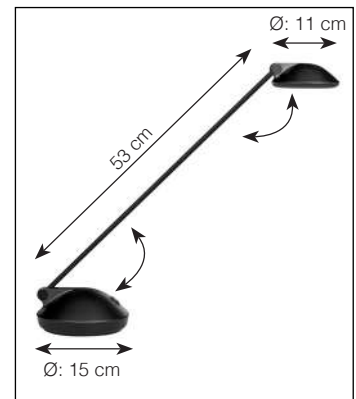

Technical features

Measurement of Luxon the worktop in 35 cm top view:

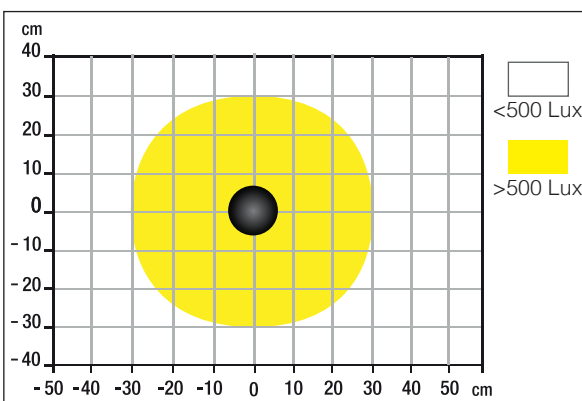

Measurement of Luxon the worktop with a 35 cm profile:

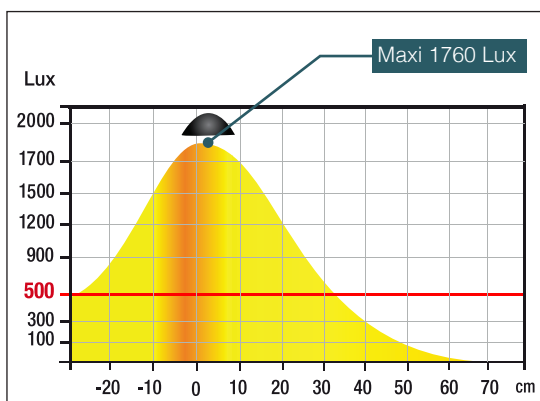

Energy class

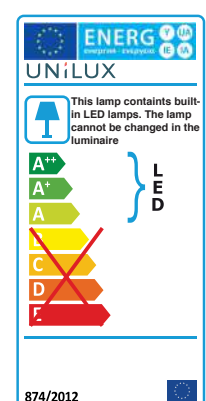





- **High performance:** its asymmetric lighting of 590 Lumens neutralizes dazzling and avoids contrasts.
- **Adjustment:** arm with a double high and low articulation allowing optimal adjustment of the product.
- **Modern design:** very pretty clean lines, with a beautiful symmetry between the head and the base. This lamp is made for any type of modern or classic environment.
- **Energetically efficient:** this lamp consumes 75% less energy than incandescent lighting and 35% less energy than fluorescent lighting for the same level of brightness. Life time: 40 000h.
- **Protect your eyes:** this desk lamp LED provides you with quality lighting and comfortable because it is flicker-free and has no drag effect for reading, work and concentration. It is pleasant for the eyes and thus reduces the effects of fatigue.

- **Rated Power:** This fixture contains built-in 6,1 W LED lights that can not be replaced
- **Lifetime * of LEDs:** 40,000 hours
- **Illumination of 1625 Lux at 35 cm**
- **Color temperature:** 3000 K
- **Weighted energy consumption:** 5,1 kWh / 1000 h
- **Luminous efficiency ** of LEDs:** 130 lm / W
- **CRI:** 82
- **2 years warranty**
- **Maximum height:** 59 cm / **minimum height:** 27 cm
- **Materials:** base and head in ABS plastic / aluminum arm epoxy finish

* Average consumption: 1000 h / year
 ** Light emission of the lighting source

Réf. product	Color	Cable length	Code EAN	EA by box
100340421	Black/ metal gray	2,7 m	3595560014859	1 pc.

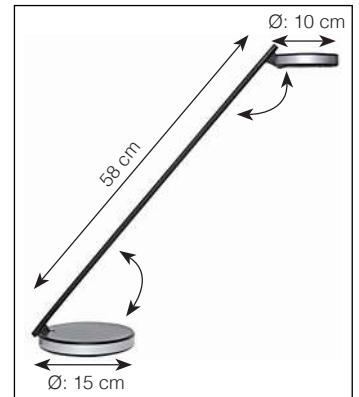

Technical features

Measurement of Lux on the worktop in 35 cm top view:

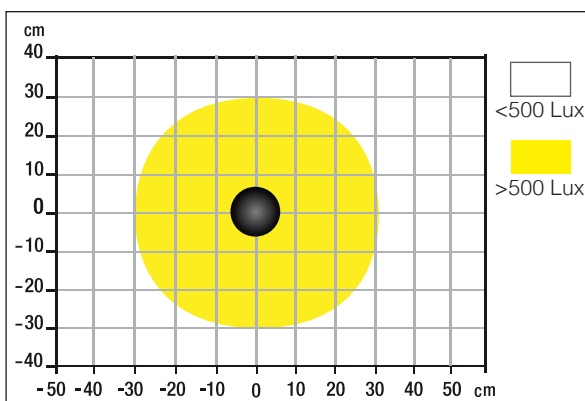

Measurement of Lux on the worktop with a 35 cm profile:

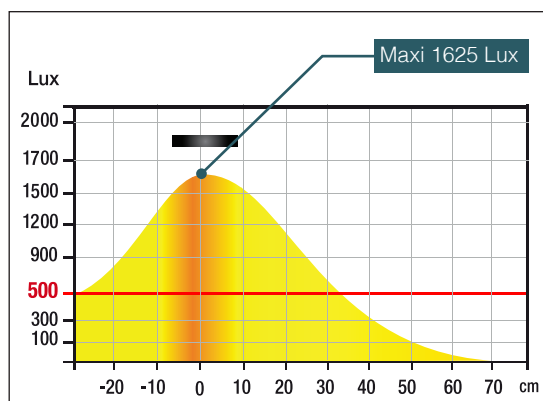

Energy class

URBAN



- **Adjustable:** the lamp is oriented in all directions thanks to its double articulation high and low.
- **Its touch ON / OFF switch:** located on its head, access is fast and easy.
- **Comfortable light for the eyes:** with its latest generation LED, the light is stable without flickering or glare. Protects your eyes well
- **Low visual stress after prolonged use:** ideal for working, reading or studying, at home or in the office.
- **Stability:** its base weighted 2.7Kg ensures perfect stability of the lamp on your desk.
- **Complementary:** lamp perfectly coordinated with UNILUX office accessories (clocks, coat hangers, footrests, ergonomic products).

- Rated power: this luminaire contains built-in LED lamps with a power of 10,9 W which can not be replaced
- Lifetime * of LEDs: 50,000 hours
- Illumination of 1580 Lux at 35 cm
- Color temperature: 2900 K
- Weighted energy consumption: 9,1 kWh / 1000 h
- Luminous efficiency ** of LEDs: 120 lm / W
- Energy efficiency: class A / A + / A ++ (spectrum A ++ to E)
- CRI: 82
- 2 years warranty
- Maximum height: 51 cm / minimum height: 28 cm
- Materials: epoxy painted steel base / aluminum arm / ABS plastic head

* Average consumption: 1000 h / year
 ** Light emission of the lighting source

Réf. product	Color	Cable length	Code EAN	EA by box
400093963	Black	2,0 m	3595560017782	1 pc.

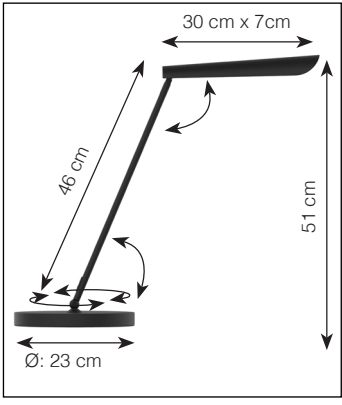

Technical features

Measurement of Lux on the worktop in 35 cm top view:

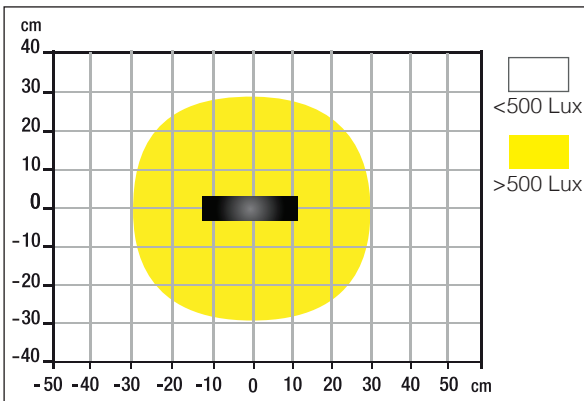

Measurement of Lux on the worktop with a 35 cm profile:

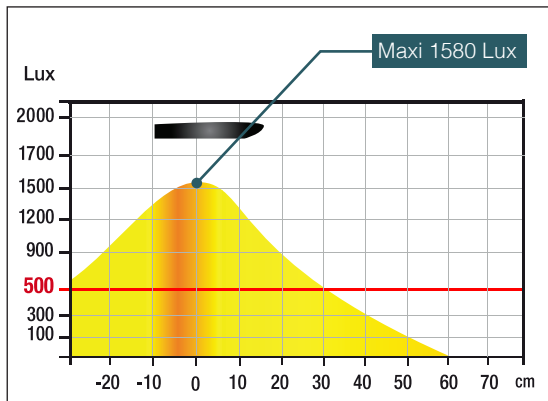

Energy class

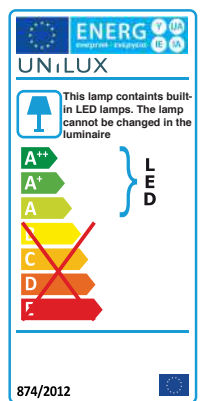



/ DIVA



THE + PRODUCT
USB + wireless charger

- **Wireless induction charging socket (5 W):** Charge your smartphone or other compatible* device by simply placing it on the lamp base.
- **USB charging port:** integrated USB 2.0 Type A connection 5 V, max. 1A, charge your smartphone or tablet (cable not supplied).
- **Brightness:** With its 3 color temperature modes and 3 levels of brightness adjustable by 2 touch buttons, this lamp is fully optimized for rest, reading, work. Choose the best quality of light for your activities.
- **Modern design:** fine and clean lines. Its aluminum head and arm give it an elegant and contemporary character giving you a product that meets your expectations.
- **Pleasant for your eyes:** low visual stress after prolonged use thanks to its different color temperatures and light intensities. Ideal for working, reading or studying, at home or in the office.

- Rated power: this luminaire contains integrated LED lamps with a power of 8,2 W which can not be replaced
- Lifetime** of LEDs: 30,000 hours
- Illumination of 1150 Lux at 40 cm
- Color temperature: 3000 K / 4000 K / 6000 K
- Weighted energy consumption: 6,8 kWh / 1 000 h
- Luminous efficiency *** of LEDs: 100 lm / W
- Energy efficiency: class A / A + / A ++ (spectrum A ++ to E)
- CRI: 81
- 2 years warranty
- Maximum height: 35 cm / minimum height: 25 cm
- Materials: ABS plastic base / aluminum arm and head

* If your smartphone does not have a wireless charging option, simply add a Qi charging shell.
 ** Average consumption: 1000 h / year
 *** Light emission of the lighting source

Réf. product	Color	Cable length	Code EAN	EA by box
400124560	Black	1,8 m	3595560029495	1 pc.

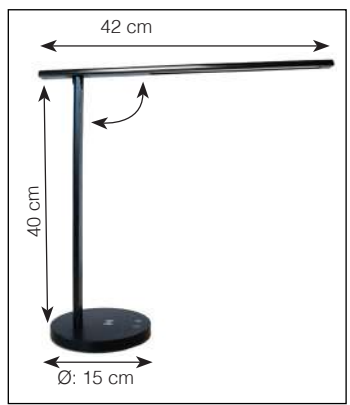

Technical features

Measurement of Lux on the worktop in 40 cm top view:

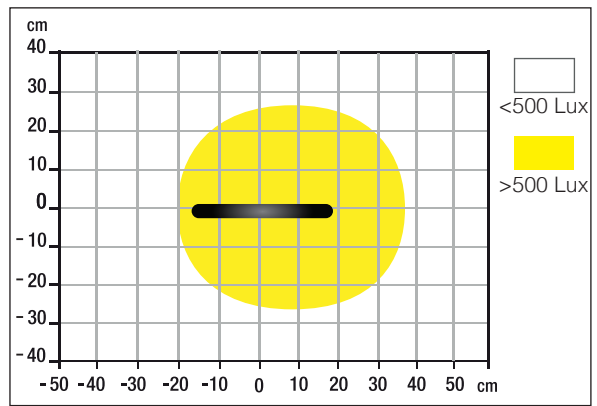

Measurement of Lux on the worktop with a 40 cm profile:

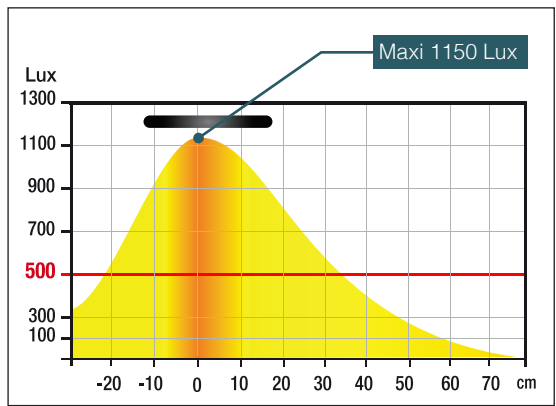

Energy class



THE + PRODUCT
Equipped with USB port

- **USB charging port:** integrated USB 2.0 Type A connection 5 V, max. 1A, charge your smartphone or tablet (cable not supplied).
- **Energy Saving:** desk lamp uses latest generation LEDs. It has a lifetime of 50,000h.
- **Scandinavian design:** sober and timeless, the wood-white combination sublimates the large interiors such as reception halls as well as the smaller contemporary spaces like contemporary offices.
- **Optimum lighting (3 levels of intensity):** the LED lighting of this lamp provides glare-free, uniform light that does not hurt your eyes.
- **Low visual stress after prolonged use:** ideal for working, reading or studying, at home or in the office.
- **Complementary products:** lamp perfectly coordinated with BALTIC clock, PRYSKA LED uplighter, ACCESS coat stand and ERGO WELL electric desk.

- Rated power: this luminaire contains integrated LED lamps with a power of 11 W which can not be replaced
- Lifespan * of LEDs: 50,000 hours
- Illumination of 2520 Lux at 35 cm
- Color temperature: 3000 K
- Weighted energy consumption: 9,2 kWh / 1000 h
- Luminous efficiency ** of LEDs: 120 lm / W
- Energy efficiency: class A / A + / A ++ (spectrum A ++ to E)
- CRI: 82
- 2 years warranty
- Maximum height: 53 cm / minimum height: 18 cm
- Materials: epoxy painted steel and wood *** beech finish

* Average consumption: 1000 h / year
 ** Light emission of the lighting source
 *** Wood from managed eco-friendly forests

Réf. product	Color	Cable length	Code EAN	EA by box
400110084	White/ beech	1,9 m	3595560028139	1 pc.

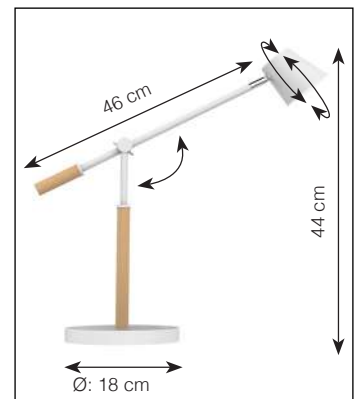

Technical features

Measurement of Lux on the worktop in 35 cm top view:

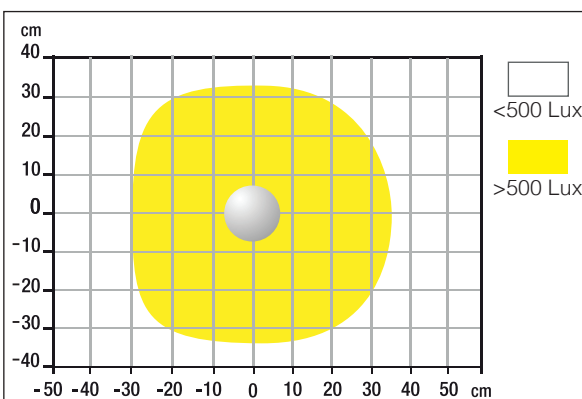

Measurement of LUux on the worktop with a 35 cm profile:

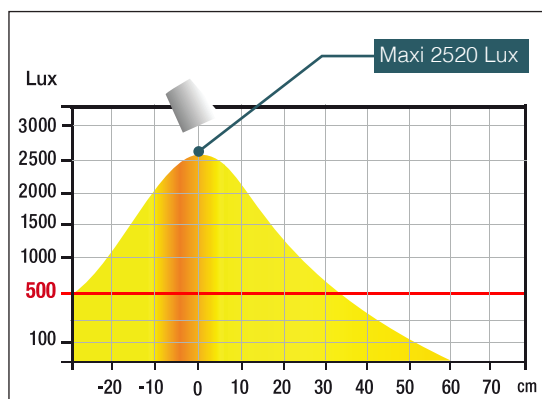

Energy class

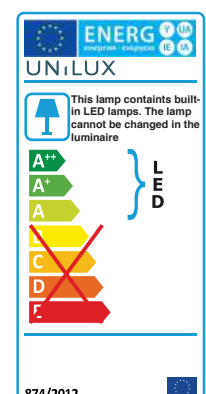

BALTIC: clock Ø: 31.5 cm
silent movement
delivered with its AA1,5V battery
p 124



PRYSKA: LED fuplighter
intensity touch dimmer
p 21



VICKY: LED lamp
intensity touch dimmer
USB port



ERGO WELL: electric desk
3 memory / alarm settings
steel base supports up to 125 Kg
p 105





THE + PRODUCT
Equipped with USB port

- **USB charging port:** integrated USB 2.0 Type A connection 5 V, max. 1A, charge your smartphone or tablet (cable not supplied).
- **The touch switch:** on the base with 4 levels of intensity and 3 levels of adjustment of the color temperature to adapt to different needs: rest, reading, work.
- **Sober and elegant design:** with an elliptical shaped head allowing an optimal diffusion of the light on the worktop. It fits perfectly to all office sizes.
- **Energetically efficient:** this lamp consumes 75% less energy than incandescent lighting and 35% less energy than fluorescent lighting for the same level of brightness.
- **Comfortable light for the eyes with its latest generation LED:** the light is stable without flickering or glare. Protects your eyes well

- **Rated power:** this luminaire contains built-in LED lamps with a power of 6,2 W which can not be replaced
- **Lifetime *** of LEDs: 40,000 hours
- **Illumination** of 925 Lux at 35 cm
- **Color temperature:** 3000K / 3500K / 4000K
- **Weighted energy consumption:** 5,2 kWh / 1000 h
- **Luminous efficiency **** of LEDs: 108 lm / W
- **Energy efficiency:** class A / A + / A ++ (spectrum A ++ to E)
- **CRI:** 82
- **2 years warranty**
- **Maximum height:** 35 cm / **minimum height:** 25 cm
- **Materials:** ABS plastic base, arm and head

* Average consumption: 1000 h / year
** Light emission of the lighting source

Réf. product	Color	Cable length	Code EAN	EA by box
400077430	Black	2,0 m	3595560012862	1 pc.

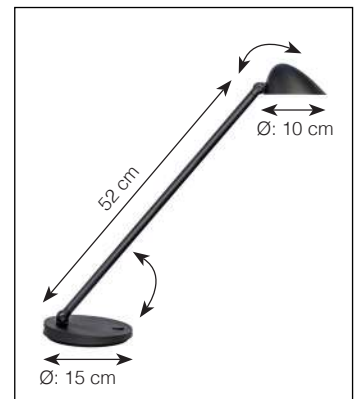

Technical features

Measurement of Lux on the worktop in 35 cm top view:

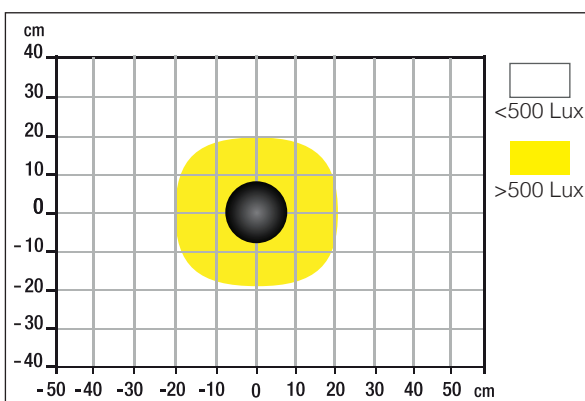

Measurement of Lux on the worktop with a 35 cm profile:

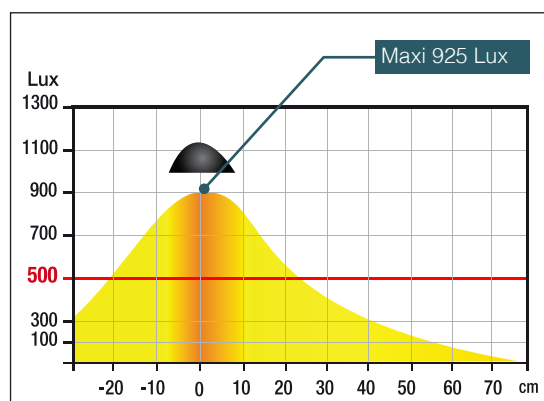

Energy class

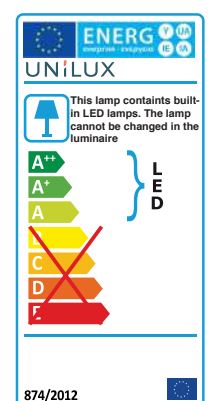

/ ULVA  



- **Easy to use:** thanks to its easily accessible touch button, this lamp offers 4 levels of light intensity, allowing everyone to adapt the lighting throughout the day according to their needs.
- **Economical:** Entry level lamp with a very attractive price
- **Protect your eyes:** this LED desk lamp provides you with quality and comfortable lighting as it is flicker-free and has no drag effect for reading, working and concentration. It is pleasant for the eyes and thus reduces the effects of fatigue.
- **Energetically efficient:** this lamp consumes 75% less energy than incandescent lighting and 35% less energy than fluorescent lighting for the same level of brightness.
- **Complementary:** lamp perfectly coordinated with UNILUX office accessories (clocks, coat hangers, footrests, ergonomic products).

- **Rated Power:** This fixture contains built-in 5,4 W LED lights that can not be replaced
- **Lifetime *** of the LEDs: 20,000 hours
- **Illumination** of 1700 Lux at 40 cm, luminous flux of 400 Lumens
- **Color temperature:** 3000 K
- **Weighted energy consumption:** 4,5 kWh / 1000 h
- **Luminous efficiency **** of LEDs: 100 lm / W
- **Energy efficiency:** class A / A + / A ++ (spectrum A ++ to E)
- **CRI:** 86
- **2 years warranty**
- **Maximum height:** 45 cm / **minimum height:** 45 cm
- **Materials:** base and ABS plastic head / recyclable aluminum arm

* Average consumption: 1000 h / year
** Light emission of the lighting source

Réf. product	Color	Cable length	Code EAN	EA by box
400012753	Metal gray	2,0 m	3595560000128	1 pc.

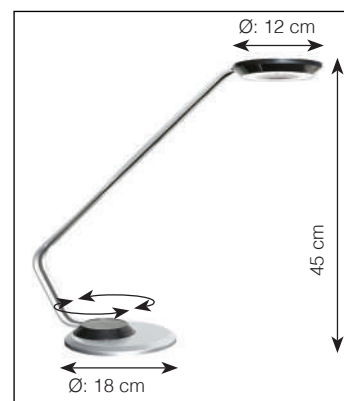

Technical features

Measurement of Lux on the worktop in 40 cm top view:

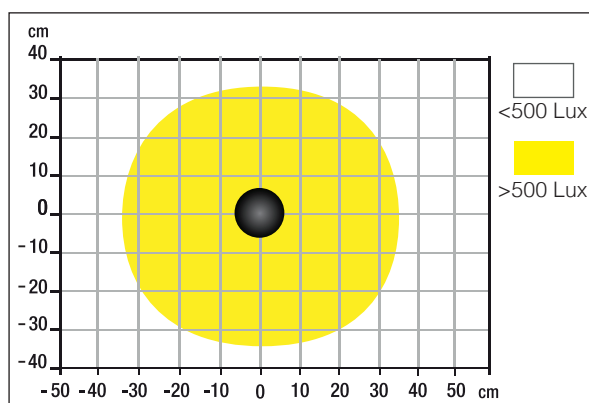

Measurement of Lux on the worktop with a 40 cm profile:

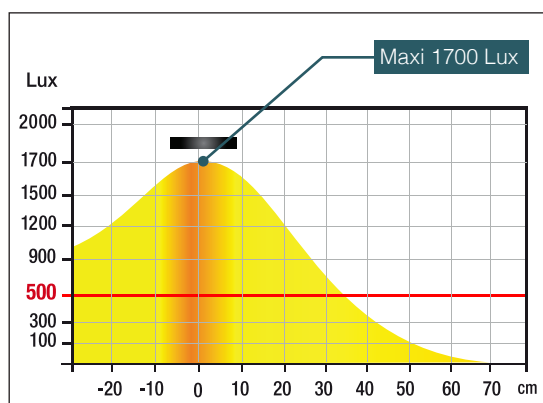

Energy class

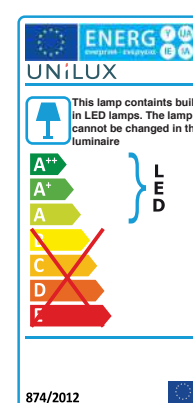



THE + PRODUCT
Equipped with USB port

- **USB charging port:** integrated USB 2.0 Type A connection 5 V, max. 1A, charge your smartphone or tablet (cable not supplied).
- **Easy to use:** thanks to its easily accessible touch button, this lamp offers 3 levels of light intensity, allowing everyone to adapt the lighting throughout the day according to their needs.
- **Adjustable:** its metal hose, elastomer-wrapped allows you to easily direct the light beam exactly where you need it by adjusting its height and angle.
- **Sleek and uncluttered design:** this lamp will perfectly integrate all the workspaces and different sizes of desks.
- **Optimum and bright lighting:** The LED lighting of this lamp provides glare-free, uniform light that does not hurt your eyes.
- **Energetically efficient:** this lamp consumes 75% less energy than incandescent lighting and 35% less energy than fluorescent lighting for the same level of brightness.

- Rated power: this luminaire contains integrated LED lamps with a power of 10,4 W which can not be replaced
- Lifetime* of LEDs: 50,000 hours
- Illumination of 1465 Lux at 35 cm, luminous flux of 500 Lumens
- Color temperature: 3000 K
- Weighted energy consumption: 8,7 kWh / 1000 h
- Luminous efficiency ** of LEDs: 120 lm / W
- Energy efficiency: class A / A + / A ++ (spectrum A ++ to E)
- CRI: 84
- 2 years warranty
- Maximum height: 48 cm / minimum height: 30 cm
- Materials: head and base in ABS plastic / metal arm with rubber surface

* Average consumption: 1000 h / year
** Light emission of the lighting source

Réf. product	Color	Cable length	Code EAN	EA by box
400093833	Black	1,8 m	3595560015580	1 pc.

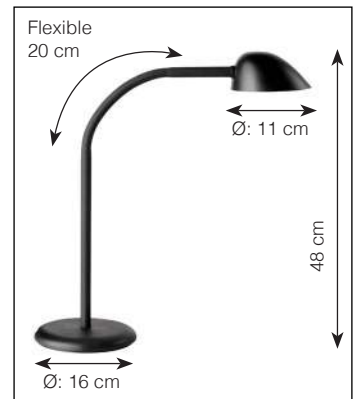

Technical features

Measurement of Lux on the worktop in 35 cm top view:

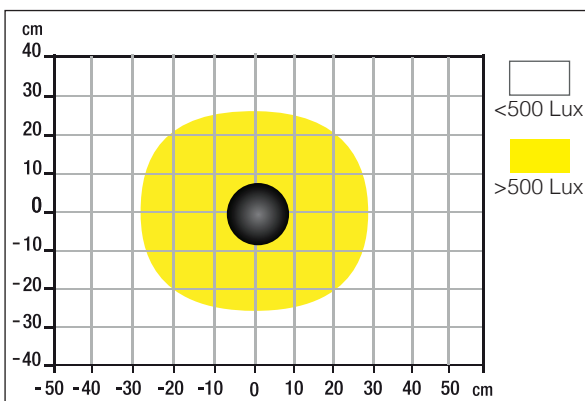

Measurement of Lux on the worktop with a 35 cm profile:

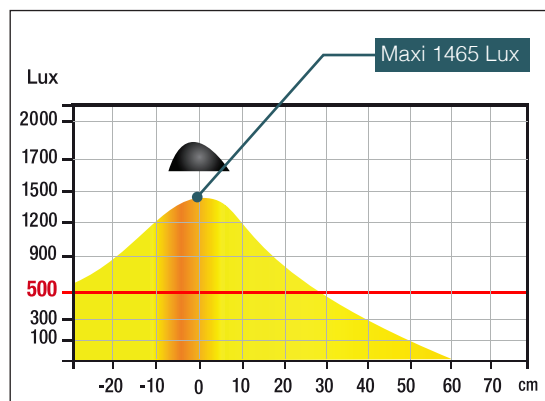

Energy class

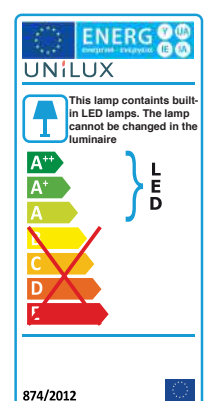

LUCY



- **Convenient:** can connect directly to a USB port.
- **Lighting:** its elongated head allows an optimal light diffusion on the worktop.
- **Touch switches on the base:** the first allows to vary the light intensity and the second rule the lighting color (3 different temperatures) adapting to different activities: rest, reading, work.
- **Modern design:** its soft and fluid lines adapt to any type of workspace environment.
- **Office lamp using latest generation LED saving energy:** it has a lifespan of 30,000 hours.
- **Low visual stress after prolonged use:** ideal for working, reading or studying, at home or in the office.
- **Available in two colours:** white or black

- **Rated power:** this luminaire contains integrated LED lamps with a power of 6,8 W which can not be replaced
- **Lifespan * of the LEDs:** 30,000 hours
- **Illumination of 940 Lux at 35 cm**
- **Color temperature:** 3200 K / 4500 K / 5200 K
- **Consumption of weighted energy:** 5,7 kWh / 1000 h
- **Luminous efficiency ** of LEDs:** 143 lm / W
- **Energy efficiency:** class A / A + / A ++ (spectrum A ++ to E)
- **CRI:** 82
- **2 years warranty**
- **Maximum height:** 35 cm / **minimum height:** 22 cm
- **Materials:** base and head in ABS plastic / metal arm with rubber surface

* Average consumption: 1000 h / year
 ** Light emission of the lighting source

Réf. product	Color	Cable length	Code EAN	EA by box
400093614	White	1,5 m	3595560014675	1 pc.
400093640	Black	1,5 m	3595560014705	1 pc.

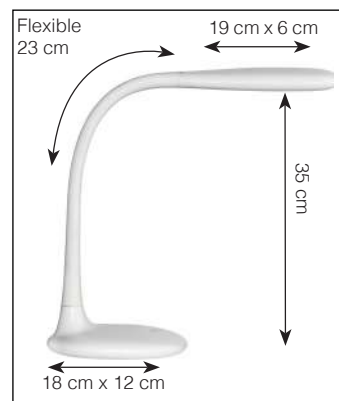

Technical features

Measurement of Lux on the worktop in 35 cm top view:

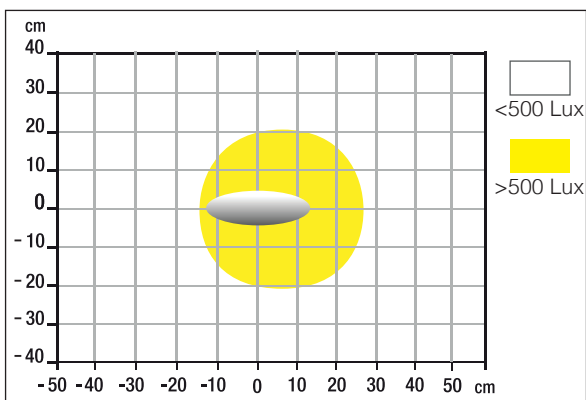

Measurement of Lux on the worktop with a 35 cm profile:

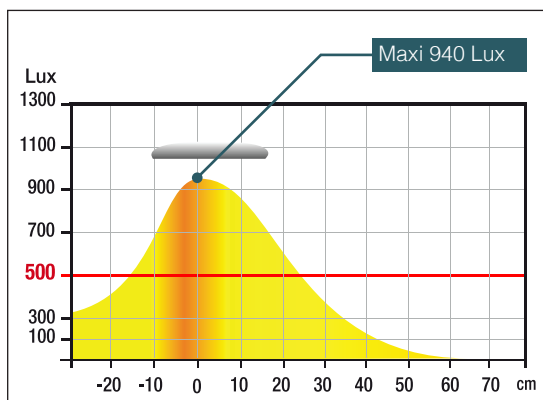

Energy class

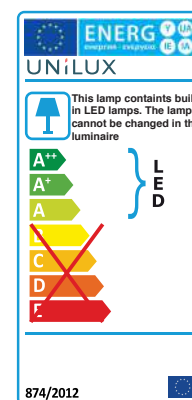

/ FLEXIO 2



- **Flexible adjustment:** Thanks to its flexible arm, the lamp has a great flexibility of adjustment in all directions to adjust the lighting in the right place on your worktop.
 - **Robustness:** thanks to its thick sheet base, this all metal lamp, with beautiful finishes.
 - **Optimum and bright lighting:** Its luminous intensity of 400 lumens offers a light without glare, uniform and which does not attack your eyes.
 - **Sobriety and modernity:** lamp with slender and dynamic design with intuitive handling.
 - **Available in 4 colours:** covered with a resistant EPOXY paint, this lamp comes in 4 colors: anise green, steel blue, black and gray metal.
 - **ON / OFF switch:** easy to access on the cord
- Nominal power: this luminaire is supplied with an E14 LED bulb with a power of 5 W
 - Lifetime * of LED bulb: 50,000 hours
 - Illuminance of 1395 Lux at 27 cm
 - Color temperature: 3000 K
 - Weighted energy consumption: 3,9 kWh / 1000 h
 - Luminous efficiency ** of the LED bulb: 100 lm / W
 - Energy efficiency: class A / A + / A ++ (spectrum A ++ to E)
 - CRI: 82
 - 2 years warranty
 - Maximum height: 35 cm / minimum height: 25 cm
 - Materials: head and pedestal in metal with EPOXY paint / metal arm

* Average consumption: 1000 h / year
 ** Light emission of the lighting source

Réf. product	Color	Cable length	Code EAN	EA by box
400093694	Green	1,8 m	3595560014941	1 pc.
400093695	Blue	1,8 m	3595560015382	1 pc.
400093687	Black	1,8 m	3595560014750	1 pc.
400093692	Metal gra	1,8 m	3595560014781	1 pc.

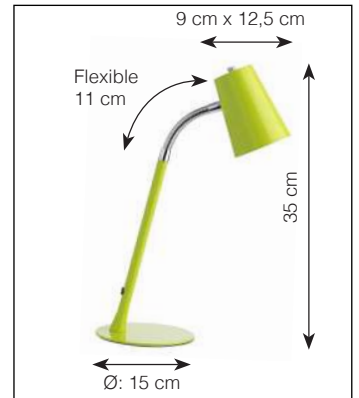

Technical features

Measurement of Lux on the worktop in 27 cm top view:

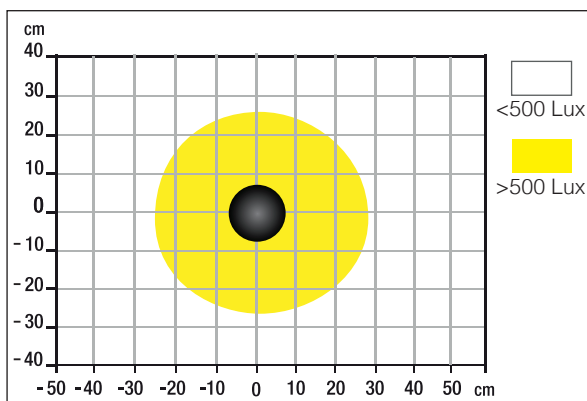

Measurement of Lux on the worktop with a 27 cm profile:

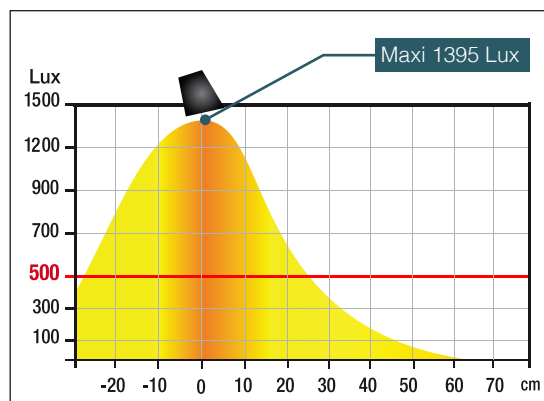

Energy class

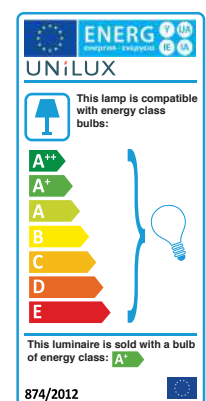

/ SOL 

- **Flexible and stable:** its flexible arm can rotate 360°. You can easily adjust the direction of the lighting to your work area; the weighted base offers excellent stability.
- **Modern and sober design:** its head shape promotes a wide diffusion of light on the worktop.
- **A pleasant light:** a stable and quality light thanks to the latest generation LEDs. In addition, these LEDs are protected by an opaque diffuser: neither flicker nor glare..
- **Energetically efficient:** this lamp consumes 75% less energy than incandescent lighting and 35% less energy than fluorescent lighting for the same level of brightness.
- **Available in 4 colours:** blue, white, red and black. Put a touch of color on your desk.
- **ON / OFF switch:** easy to access on the cord
- **Rated power:** this luminaire contains integrated LED lamps with a power of 7,4 W that can not be replaced
- **Lifetime *** of the LEDs: 20,000 hours
- **Illuminance** of 1260 Lux at 35 cm
- **Color temperature:** 3000 K
- **Weighted energy consumption:** 6,2 kWh / 1000 h
- **Luminous efficiency **** of LEDs: 120 lm / W
- **Energy efficiency** class A / A + / A ++ (spectrum A ++ to E)
- **CRI:** 82
- **2 years warranty**
- **Maximum height:** 45 cm / **minimum height:** 30 cm
- **Materials:** head and base in ABS plastic / metal arm with rubber surface

* Average consumption: 1000 h / year

** Light emission of the lighting source

Réf. product	Color	Cable length	Code EAN	EA by box
400077402	Black	1,8 m	3595560012794	1 pc.
400077404	White	1,8 m	3595560012800	1 pc.
400077405	Blue	1,8 m	3595560012817	1 pc.
400077406	Red	1,8 m	3595560012824	1 pc.



Technical features

Measurement of Lux on the worktop in 35 cm top view:

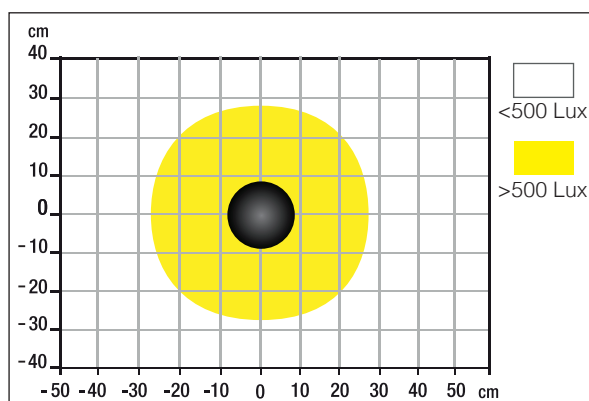

Measurement of Lux on the worktop with a 35 cm profile:

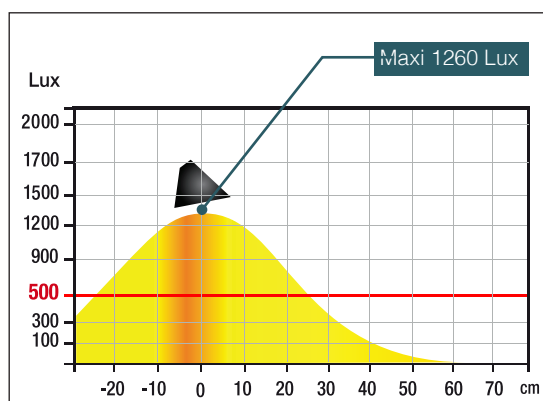

Energy class

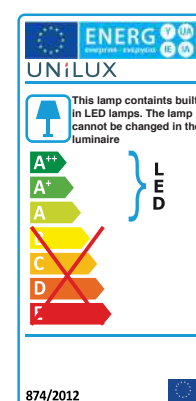

MAGIC



- **Convenient to use:** The intensity dimmer is fully adjustable, just touch the touch button to adjust the light.
- **Smart:** The memory feature allows you to adjust the brightness once, it will automatically return to your setting when you turn it back on.
- **Ecological lighting:** an automatic shutdown system is done after 5 hours of use.
- **Modern design:** the finesse of its lines and the fluidity of this lamp give it an elegant character, which will seduce you and harmonize perfectly with your office.
- **Adjustment:** high amplitude and flexibility thanks to its double arm with its 360 ° swivel joint on the base, thus ensuring an excellent diffusion of light on your desk, taking care of your eyes.
- **Asymmetrical lighting:** equipped with asymmetric lighting that neutralizes much of the glare and greatly increases the illuminated area.
- **Low visual stress after prolonged use:** ideal for working, reading or studying, at home or in the office.

- Rated power: this luminaire contains built-in LED lamps with a power of 8,4 W which can not be replaced
- Lifetime * of LEDs: 40,000 hours
- Illuminance of 1810 Lux at 35 cm
- Color temperature: 3000 K
- Weighted energy consumption: 7 kWh / 1000 h
- Luminous efficiency ** of LEDs: 100 lm / W
- Energy efficiency: class A / A + / A ++ (spectrum A ++ to E)
- CRI: 84
- 2 years warranty
- Maximum height: 50 cm / minimum height: 30 cm
- Materials: ABS plastic base / aluminum arm / ABS plastic and aluminum head

* Average consumption: 1000 h / year
 ** Light emission of the lighting source

Réf. product	Color	Cable length	Code EAN	EA by box
400016681	Black	2,0 m	3595560002238	1 pc.

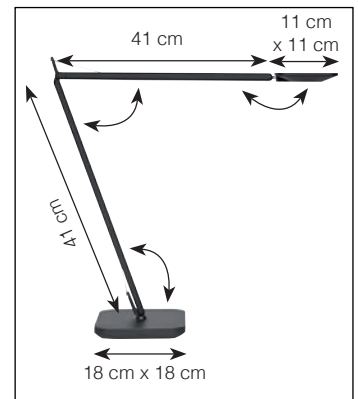

Technical features

Measurement of Lux on the worktop in 35 cm top view:

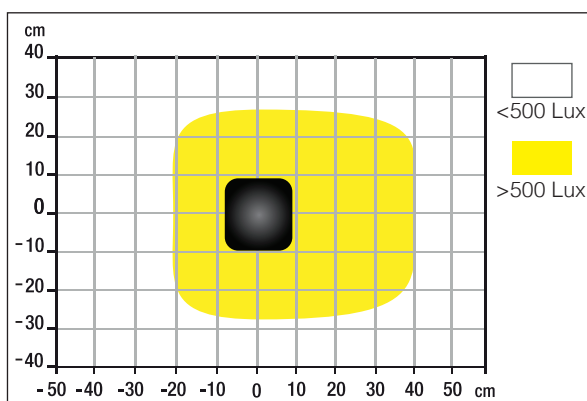

Measurement of Lux on the worktop with a 35 cm profile:

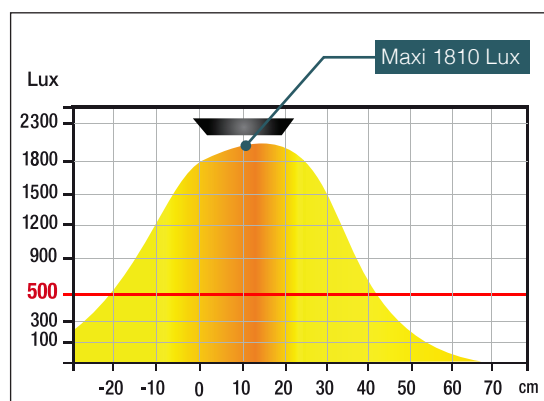

Energy class

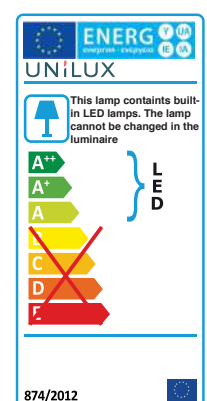

/ DOUBLE ARM LAMPS / ARCHITECT LAMPS



/ SENZA 2



- **Brightness:** multiple settings with 2 color temperature modes to choose from and 4 levels of brightness adjustable by touch button, this lamp is fully optimized for rest, reading, work. Choose the best quality of light for your activities.
- **Smart:** the memory feature allows you to adjust the brightness once, it will automatically return to your setting when you turn it back on.
- **Adjustment:** Great amplitude and flexibility thanks to its double arm, its triple articulation and its head that can be turned in any direction.
- **Contemporary design:** the worked design of the head and the fineness of the arm give a pure and original line to the lamp. It fits both in the office and at home.
- **Energetically efficient:** this lamp consumes 75% less energy than incandescent lighting and 35% less energy than fluorescent lighting for the same level of brightness. Life time: 50,000h.
- **Take care of your eyes:** latest generation LED lighting, high quality, uniform, without flickering and glare. It has no harmful radiation to the eyes and avoids eyestrain.

- Rated power: this luminaire contains integrated LED lamps with a power of 8 W which can not be replaced
- Lifetime * of LEDs: 50,000 hours
- Illumination of 1140 Lux at 35 cm
- Color temperature: 3000 K / 4500 K / 6500 K
- Weighted energy consumption: 6,7 kWh / 1000 h
- Luminous efficiency ** of LEDs: 100 lm / W
- Energy efficiency: class A / A + / A ++ (spectrum A ++ to E)
- CRI: 86
- 2 years warranty
- Maximum height: 69 cm / minimum height: 25 cm
- Materials: metal base / aluminum arm / ABS plastic head

* Average consumption: 1000 h / year
 ** Light emission of the lighting source

Réf. product	Color	Cable length	Code EAN	EA by box
400092054	Metal gray	1,9 m	3595560014286	1 pc.

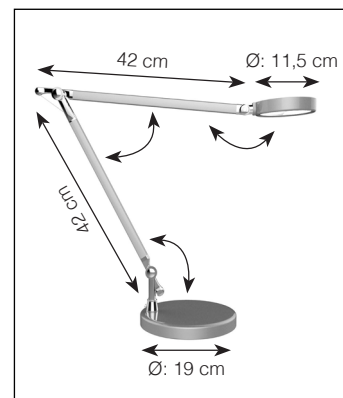
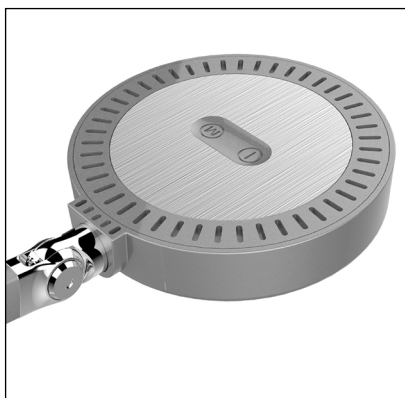

Technical features

Measurement of Lux on the worktop in 35 cm top view:

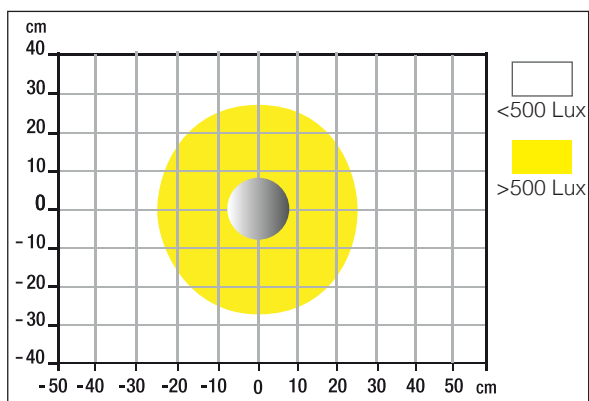

Measurement of Lux on the worktop with a 35 cm profile:

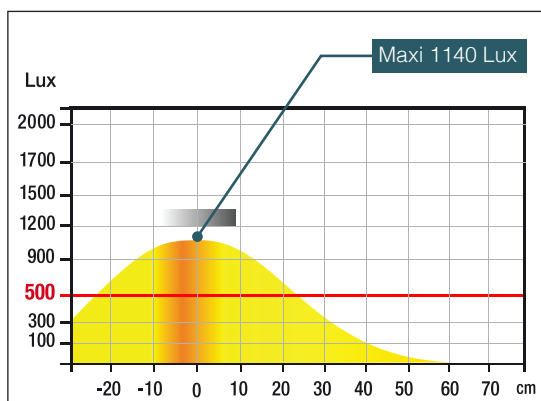

Energy class

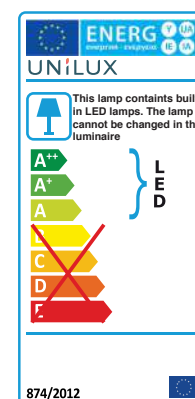

/ SWINGO LED



- **Adjustable brightness 3 levels:** the touch switch offers 3 levels of light intensity. Choose the most appropriate light intensity throughout the day to better meet your needs.
- **Contemporary design:** combining metal and plastic this lamp will adapt perfectly to any type of office.
- **Stability:** its base weighted 2.7Kg ensures perfect stability of the lamp on your desk.
- **Versatile:** it is sold on pedestal and with clamp (max spacing 5,5 cm) and adapts to all uses.
- **Comfortable light for the eyes:** with its latest generation LED, the light is stable without flickering or glare. Protects your eyes well
- **Office lamp using the latest generation LED, saving energy:** it has a lifetime of 50 000h.
- **Available in colours:** black or white

- Rated power: this luminaire contains built-in LED lamps with a power of 11 W which can not be replaced
- Lifetime * of LEDs: 50,000 hours
- Illumination of 1710 Lux at 35 cm
- Color temperature: 3000K
- Weighted energy consumption: 9,2 kWh / 1000 h
- Luminous efficiency ** of LEDs: 120 lm / W
- Energy efficiency: class A / A + / A ++ (spectrum A ++ to E)
- CRI: 82
- 2 years warranty
- Maximum height: 70 cm / minimum height: 20 cm
- Materials: epoxy painted steel base / aluminum arm / ABS plastic head

* Average consumption: 1000 h / year
 ** Light emission of the lighting source

Réf. product	Color	Cable length	Code EAN	EA by box
400093838	Black	1,8 m	3595560016495	1 pc.
400093839	White	1,8 m	3595560016570	1 pc.

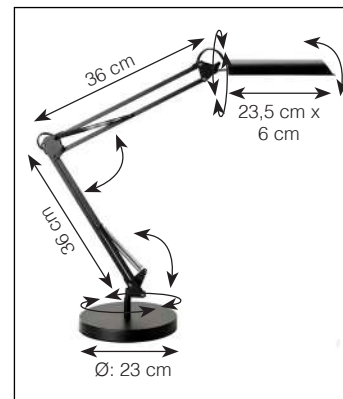

Technical features

Measurement of Lux on the worktop in 35 cm top view:

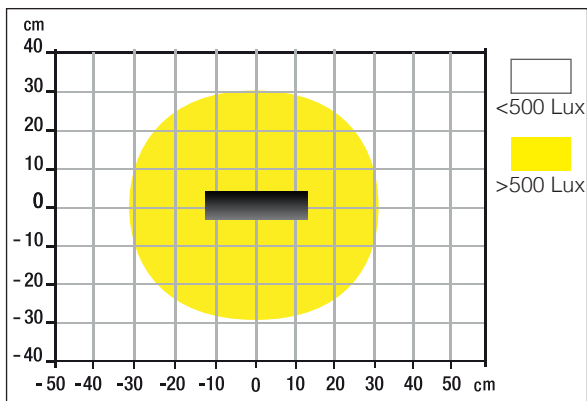

Measurement of Lux on the worktop with a 35 cm profile:

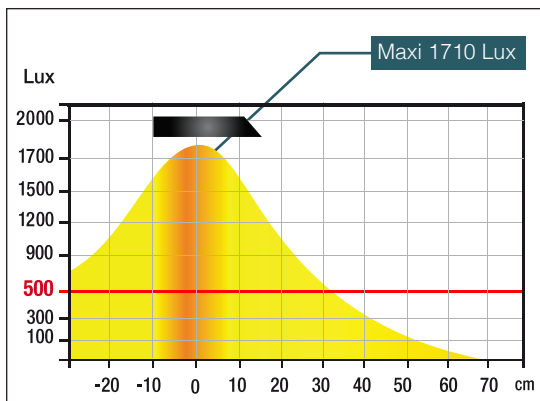

Energy class

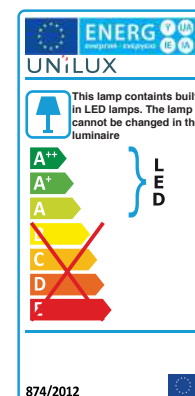

/ MAMBOLED



- **Adjustment:** large amplitude and flexibility of adjustment thanks to its double arm and its triple articulation.
- **Modern design:** with its matte black finish, this lamp will adapt perfectly to any type of office.
- **Stability:** its base weighted 1.6 Kg ensures perfect stability of the lamp on your desk.
- **Versatile:** it is sold on pedestal and with its pliers (maximum spacing 4 cm) and adapts to all uses.
- **A pleasant light, equipped with a technology protecting your eyes:** a stable and quality light thanks to the latest generation LEDs. In addition, LEDs are protected by an opaque plastic: neither flicker nor glare.
- **Low visual stress after prolonged use:** ideal for working, reading or studying, at home or in the office.

- Rated power: this luminaire contains built-in LED lamps with a power of 7 W that can not be replaced
- Lifetime* of LEDs: 40,000 hours
- Illumination of 1235 Lux at 35 cm
- Color temperature: 3000 K
- Weighted energy consumption: 5,8 kWh / 1000 h
- Luminous efficiency ** of LEDs: 110 lm / W
- Energy efficiency: class A / A + / A ++ (spectrum A ++ to E)
- CRI: 83
- 2 years warranty
- Max height: 75 cm / min height: 30 cm
- Materials: Epoxy painted steel base/ ABS plastic arm and head

* Average consumption: 1000 h / year
 ** Light emission of the lighting source

Réf. product	Color	Cable length	Code EAN	EA bybox
400033683	Black	2,0 m	3595560005796	1 pc.
400033684	Metal gray	2,0 m	3595560005802	1 pc.

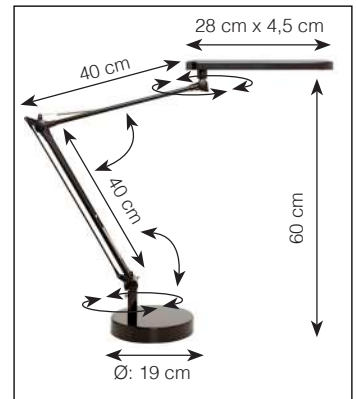

Technical features

Measurement of Lux on the worktop in 35 cm top view:

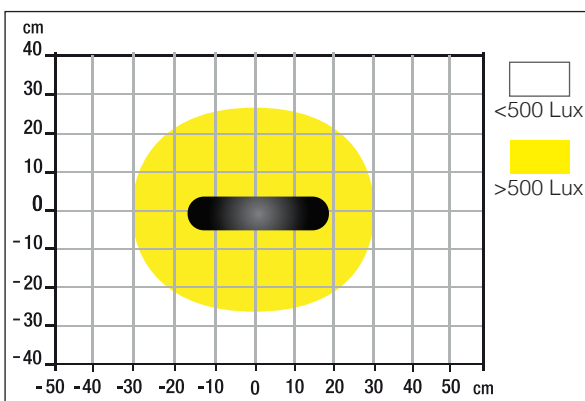

Measurement of Lux on the worktop with a 35 cm profile:

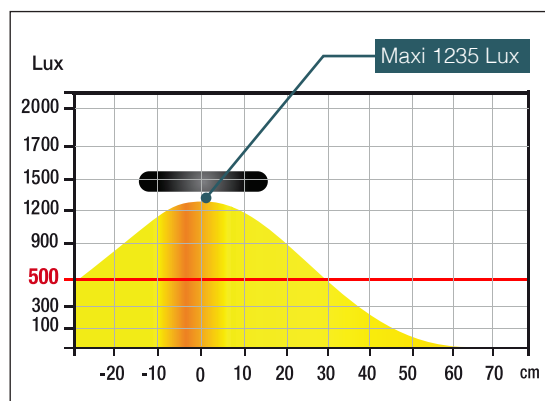

Energy class

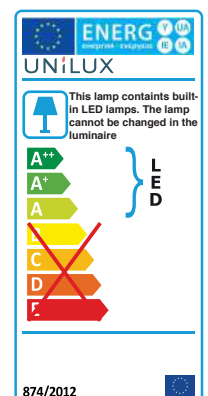

/ SUCCESS 105



- **Handy:** thanks to its swivel arm with double articulation, this lamp is equipped with compensation springs facilitating its orientation in all directions.
- **Timeless lamp:** universal and timeless design that seduced for decades
- **Optimal and uniform diffusion:** thanks to its LED with natural lighting, it will better protect your vision, reduce the tension and fatigue of your eyes.
- **Large size architect lamp:** ultra manageable, ideal for artistic activities, large architectural offices, workbenches.

- Nominal power: this luminaire is supplied with an E27 LED bulb with a power of 12,6 W
- Lifetime * of the LED bulb: 30,000 hours
- Illumination of 1090 Lux at 35 cm
- Color temperature: 3000 K
- Weighted energy consumption: 10,5 kWh / 1000 h
- Luminous efficiency ** of LEDs: 100 Lm / w
- Energy efficiency: class A / A + / A ++ (spectrum A ++ to E)
- CRI: 82
- 2 years warranty
- Maximum height: 75 cm / minimum height: 15 cm
- Materials: arm and head in epoxy painted steel and recyclable aluminum

* Average consumption: 1000 h / year
 ** Light emission of the lighting source

Réf. product	Color	Cable length	Code EAN	EA by box
400093996	Black	2,0 m	3595560020959	1 pc.

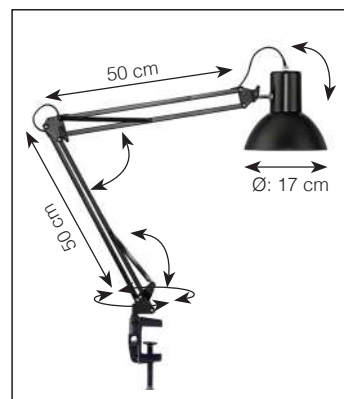

Technical features

Measurement of Lux on the worktop in 35 cm top view:

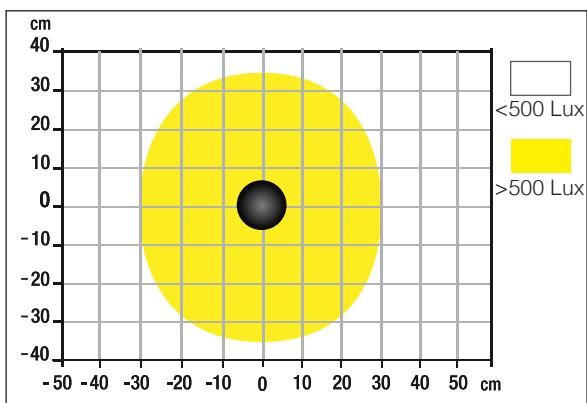

Measurement of Lux on the worktop with a 35 cm profile:

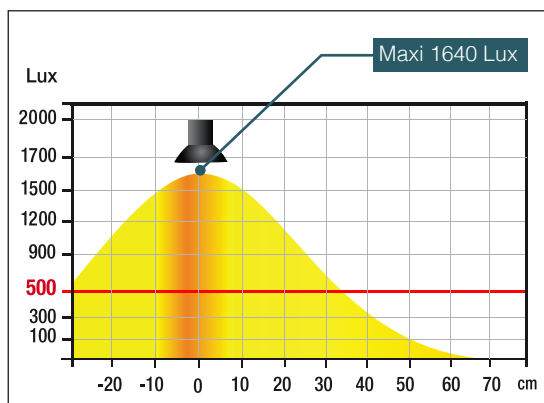

Energy class

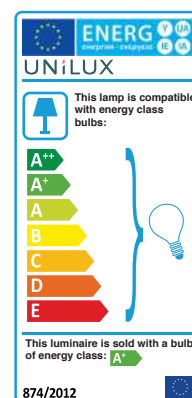

/ SUCCESS 80 CHROME



- **Handy:** thanks to its pivoting arm with double joint, this lamp is equipped with compensation springs to facilitate its orientation in all directions.
- **Upscale design:** its universal and timeless design has been appealing for years thanks to its quality chrome finish.
- **Protect your eyes:** this LED desk lamp provides you with quality and comfortable lighting as it is flicker-free and has no drag effect for reading, working and concentration. It is pleasant for the eyes and thus reduces the effects of fatigue.
- **Stability:** its weighted base, ensures perfect stability of the lamp on your desk.
- **Versatile:** it is sold on pedestal and with clamp (max spacing 5 cm) and adapts to all uses.

- Nominal power: this luminaire is supplied with an LED bulb base E27 with a power of 12,6 W
- Lifetime * of the LED bulb: 30,000 hours
- Illumination of 1640 Lux at 35 cm
- Color temperature: 3000 K
- Weighted energy consumption: 10,5 kWh / 1000 h
- Luminous efficiency ** of LEDs: 100 lm / W
- Energy efficiency: class A / A + / A ++ (spectrum A ++ to E)
- CRI: 82
- 2 years warranty
- Maximum height: 55 cm / minimum height: 15 cm
- Materials: pedestal, arm and head in epoxy painted steel and recyclable aluminum

* Average consumption: 1000 h / year
 ** Light emission of the lighting source

Réf. product	Color	Cable length	Code EAN	EA by box
400092123	Chrome	2,0 m	3595560014255	1 pc.

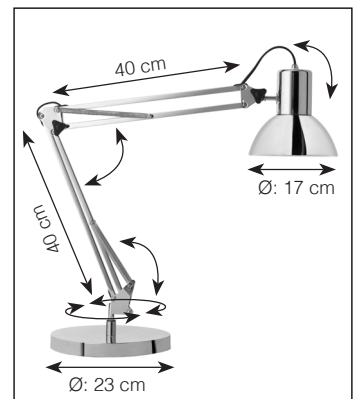

Technical features

Measurement of Lux on the worktop in 35 cm top view:

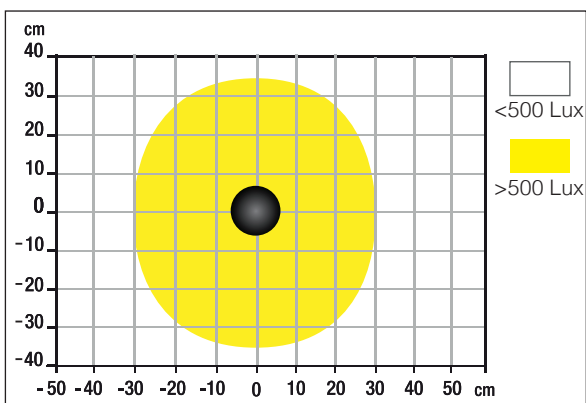

Measurement of Lux on the worktop with a 35 cm profile:

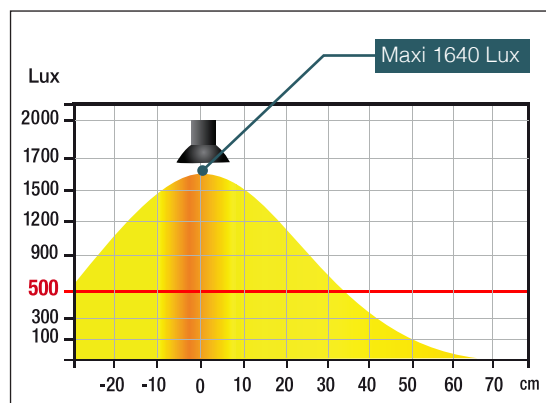

Energy class

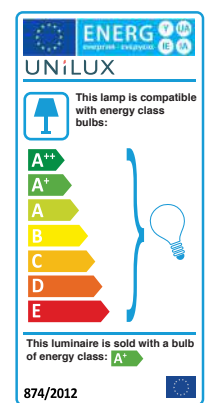



/ SUCCESS 60/80 ⏻



- **Handy:** thanks to its pivoting arm with double joint, this lamp is equipped with compensation springs to facilitate its orientation in all directions.
- **Timeless lamp:** universal and timeless design that seduced for decades.
- **Stability:** its weighted base, ensures perfect stability of the lamp on your desk.
- **Versatile:** it is sold on pedestal and with clamp (max spacing 5 cm) and adapts to all uses.
- **Available in 2 colours:** black or white
- **Available in two arm sizes:** 66 cm or 80 cm

- Nominal power: this luminaire is supplied without bulb (socket E27)
- Compatible with Class A / A + / A ++ bulbs (spectrum A ++ to E)
- 2 years warranty
- Maximum height: 55 cm / minimum height: 15 cm
- Materials: pedestal, arm and head in epoxy painted steel and recyclable aluminum

Réf. produit	Color	Cable length	Code EAN	EA by box
400093600	Black 66	2,0 m	3595560014552	1 pc.
400093579	Black 80	2,0 m	3595560014613	1 pc.
400093610	White 80	2,0 m	3595560014644	1 pc.



Version 66

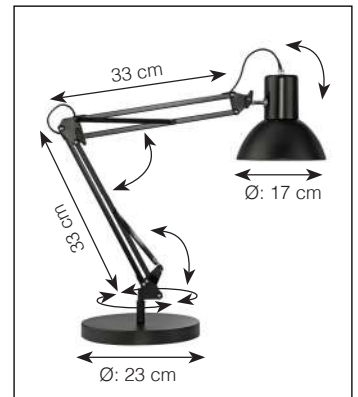

Version 80

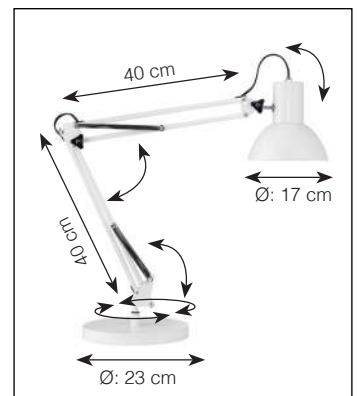

/ RUMBALED



- **Compact and articulated:** it integrates with all sizes and office spaces.
- **Stable:** its thick sheet metal base makes this lamp a resistant product with great stability.
- **Trendy design:** the finesse of the head and its elongated shape promotes a wide diffusion of light on the worktop.
- **Energetically efficient:** this lamp consumes 75% less energy than incandescent lighting and 35% less energy than fluorescent lighting for the same level of brightness.
- **Securing:** flicker-free light, provides a powerful and comfortable light that protects your eyes and causes less fatigue.
- **Simple and effective:** its ON / OFF switch located on the cord is easy to access.

- Rated power: this luminaire contains integrated LED lamps with a power of 5,2 W that can not be replaced
- Lifetime * of LEDs: 50,000 hours
- Illumination of 1090 Lux at 35 cm
- Color temperature: 4000 K
- Weighted energy consumption: 4,3 kWh / 1000 h
- Luminous efficiency ** of LEDs: 135 lm / W
- Energy efficiency: class A / A + / A ++ (spectrum A ++ to E)
- CRI: 82
- 2 years warranty
- Max height: 40 cm / minimum height: 20 cm
- Materials: base and arms in metal with epoxy paint / ABS plastic head

* Average consumption: 1000 h / year

** Light emission of the lighting source

Réf. product	Color	Cable length	Code EAN	EA by box
400093720	Black	1,8 m	3595560015443	1 pc.



Technical features

Measurement of Lux on the worktop in 35 cm top view:

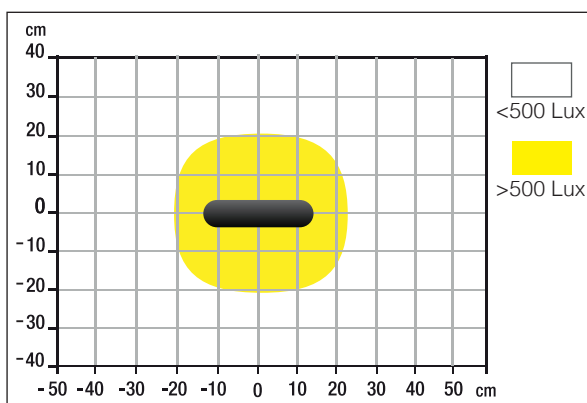

Measurement of Lux on the worktop with a 35 cm profile:

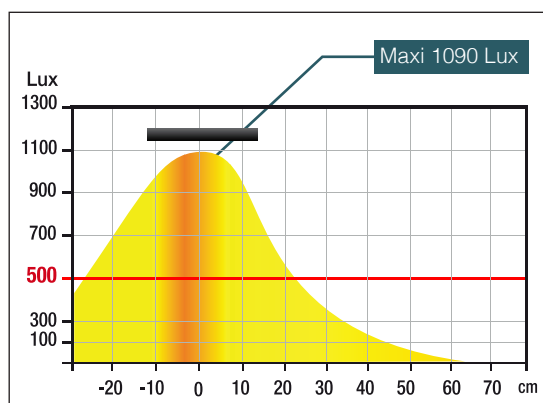

Energy class

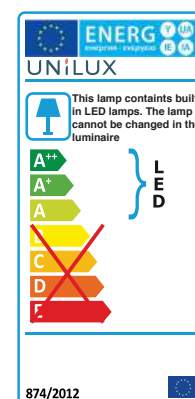



THE + PRODUCT
USB + wireless charger



- **The + product:** Ideal to store it in a drawer or a bag to accompany you on your travels (office, meeting room, traveling).
- **Wireless induction charging socket (5 W):** Charge your smartphone or other compatible* device by simply placing it on the lamp base.
- **USB charging port:** integrated USB 2.0 Type A connection 5 V, max. 1A, charge your smartphone or tablet (cable not supplied).
- **Variation of light intensity and color temperature:** on the base, two touch switches allow to vary the light intensity continuously and another to adjust the color temperature to 4 levels. Adapt your lighting according to your activity (rest, reading, work).
- **Modern and sober design:** LINKA is distinguished by a design with fine and clean lines. Its head does not exceed 1 cm in thickness which gives it an elegant character.
- **Optimal and even distribution of light thanks to its LEDs with natural lighting:** it will better protect your vision, reduce the tension and fatigue of your eyes.

- Rated power: this luminaire contains integrated LED lamps with a power of 6,4 W which can not be replaced
- Lifetime ** of LEDs: 50,000 hours
- Illumination of 1695 Lux at 35 cm
- Color temperature: 2800K / 3400K / 4500K / 5600K
- Weighted energy consumption: 5,3 kWh / 1000 h
- Luminous efficiency ** of LEDs: 111 lm / W
- Energy efficiency: class A / A + / A ++ (spectrum A ++ to E)
- CRI: 82
- 2 years warranty
- Maximum height: 35 cm / minimum height: 22 cm
- Materials: head and base in ABS plastic / aluminum arm

* If your smartphone does not have a wireless charging option, simply add a Qi charging shell.
 ** Average consumption: 1000 h / year
 *** Light emission of the lighting source

Réf. product	Color	Cable length	Code EAN	EA by box
400124484	Black	1,0 m	3595560029402	1 pc.



Technical features

Measurement of Lux on the worktop in 35 cm top view:

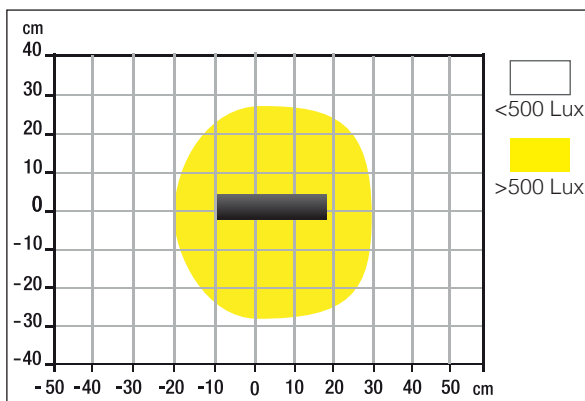

Measurement of Lux on the worktop with a 35 cm profile:

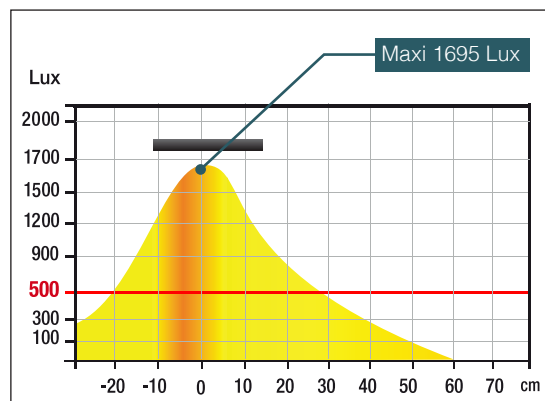

Energy class

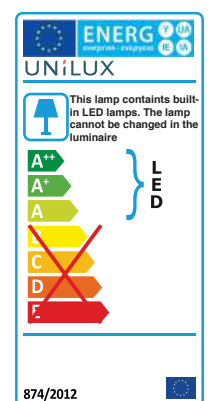

/ FOLDING LAMPS



/ JAZZ



THE + PRODUCT
USB +
wireless
charger

- **Wireless induction charging socket (5 W):** Charge your smartphone or other compatible* device by simply placing it on the lamp base.
- **USB charging port:** integrated USB 2.0 Type A connection 5 V, max. 1A, charge your smartphone or tablet (cable not supplied).
- **Brightness:** multiple settings, with its 3 color temperature modes to choose from and 5 levels of brightness adjustable by touch button, this lamp is fully optimized for rest, reading, work. Choose the best quality of light for your activities.
- **Modern and sober design:** fine and clean lines. Its head does not exceed 1 cm in thickness which gives it an elegant character.
- **Smart:** The memory feature allows you to adjust the brightness once, it will automatically return to your setting when you turn it back on.
- **Automatic:** depending on the ambient light of your workspace, the lamp adapts its light for a better visual comfort, thanks to its brightness sensor.

- Rated power: this luminaire contains integrated LED lamps with a power of 13,7 W which can not be replaced
- Lifetime ** of LEDs: 50,000 hours
- Illuminance of 1030 Lux at 35 cm
- Color temperature: 3000 K / 4000 K / 5000 K
- Weighted energy consumption: 11,4 kWh / 1000 h
- Luminous efficiency *** of LEDs: 139 lm / W
- Energy efficiency: class A / A + / A ++ (spectrum A ++ to E)
- CRI: 80
- 2 years warranty
- Maximum height: 35 cm / minimum height: 25 cm
- Materials: base and ABS plastic head / aluminum arm

* If your smartphone does not have a wireless charging option, simply add a Qi charging shell.

** Average consumption: 1000 h / year

*** Light emission of the lighting source

Réf. product	Color	Cable length	Code EAN	EA by box
400093836	White	1,6 m	3595560016327	1 pc.

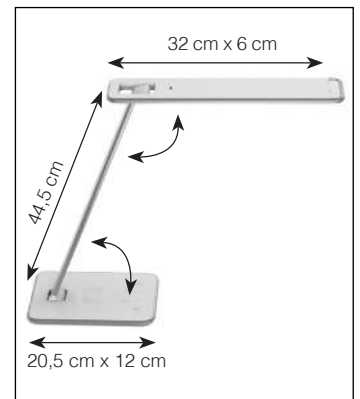

Technical features

Measurement of Lux on the worktop in 35 cm top view:

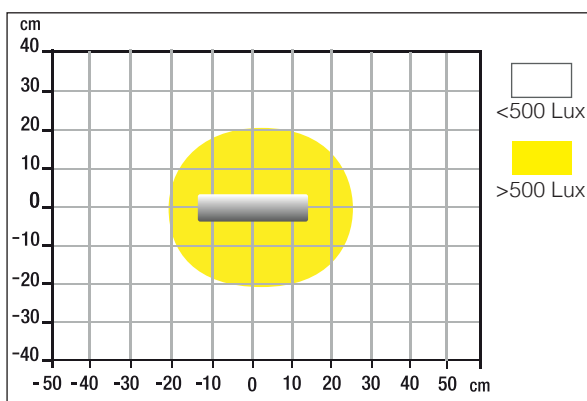

Measurement of Lux on the worktop with a 35 cm profile:

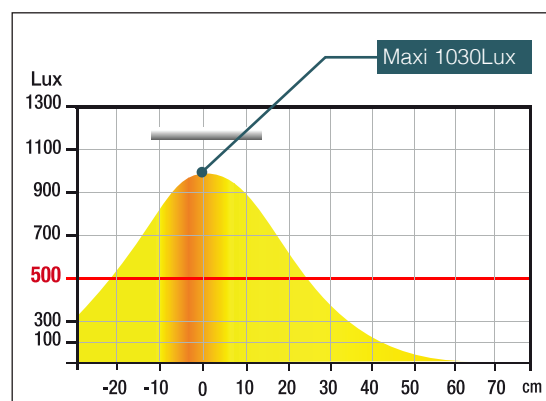

Energy class

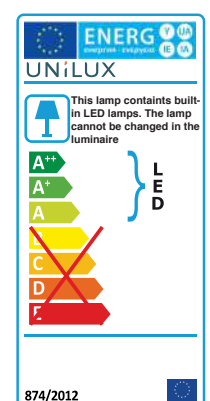





- **The + product:** Ideal to store it in a drawer or a bag to accompany you on your travels (office, meeting room, traveling).
- **Adjustable brightness 4 levels:** the touch switch offers 4 levels of white color. Choose the most appropriate light intensity throughout the day to better meet your needs.
- **Flexibility:** with its +/- 120 ° movable head, 90 ° adjustable arm and +/- 30 ° rotating base (right and left), this lamp can be used in a variety of positions and its base is specially designed to provide the latter with excellent stability.
- **Modern design:** with its sleek and clean lines, its head does not exceed 1 cm in thickness which gives it an elegant character.
- **Office lamp using the latest generation LED, saving energy:** it has a lifetime of 40 000h.
- **Protects your eyes:** stable light without flickering or glare. Low visual stress after prolonged use, ideal for working, reading or studying, at home or in the office.

- Rated power: this luminaire contains integrated LED lamps with a power of 8,3 W which can not be replaced
- Lifetime * of LEDs: 40,000 hours
- Illuminance of 1120 Lux at 35 cm
- Color temperature: 3300 K
- Weighted energy consumption: 6,9 kWh / 1000 h
- Luminous efficiency ** of LEDs: 134 lm / W
- Energy efficiency: class A / A + / A ++ (spectrum A ++ to E)
- CRI: 82
- 2 years warranty
- Max height: 40 cm / min height: 30 cm
- Materials: recyclable aluminum head, arm and base / ABS plastic end caps

* Average consumption: 1000 h / year
 ** Light emission of the lighting source

Réf. produit	Color	Cable length	Code EAN	Qté/carton
400077409	Metal gray	2,0 m	3595560012855	1 pc.

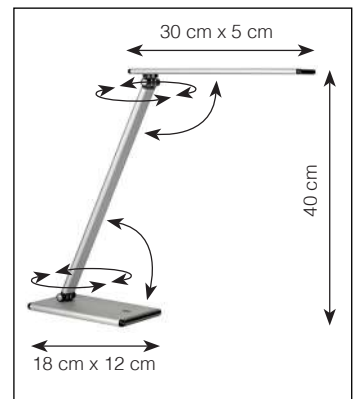

Technical features

Measurement of Lux on the worktop in 35 cm top view:

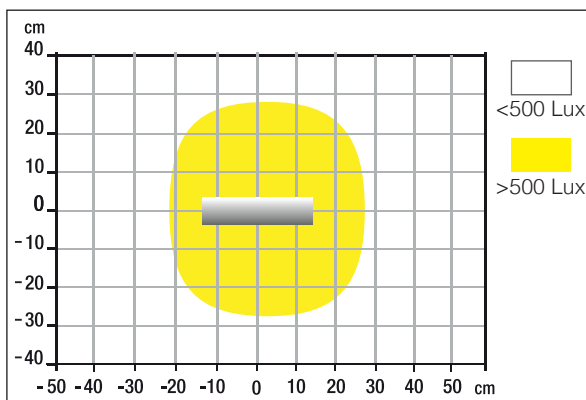

Measurement of Lux on the worktop with a 35 cm profile:

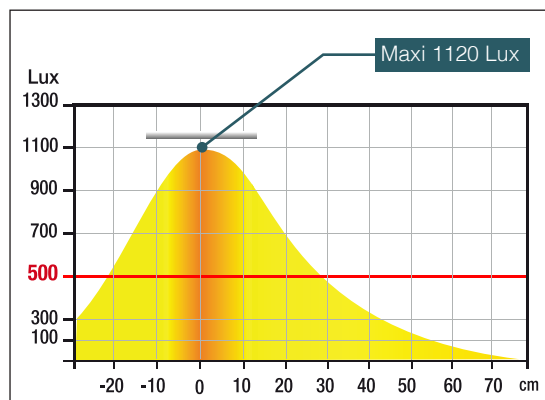

Energy class

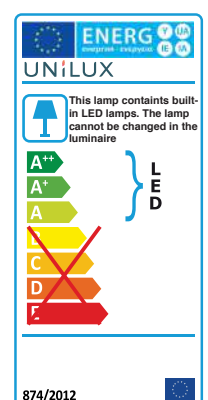

POPY



THE + PRODUCT
Folding lamp

- **The + product:** Ideal to store it in a drawer or a bag to accompany you on your travels (office, meeting room, traveling). Can connect directly to a USB port
 - **Variation of light intensity and color temperature:** on the base, the touch switch allows to vary the 3 color temperature levels by a brief pressure and the light intensity by a continuous pressure.
 - **Modern design lamp:** it stands out for its sleek and clean lines supported by its glass base. The alliance of glass and aluminum makes the POPY the perfect accessory to add a touch of modernism to your office.
 - **Nightlight mode:** provides a soft light located at the base that can be used as a night light.
 - **Stability and solidity:** its 1cm thick, weighted glass base ensures perfect lamp stability no matter where you put it.
 - **Low visual stress after prolonged use:** ideal for working, reading or studying, at home or in the office
- Rated power: this luminaire contains integrated LED lamps with a power of 5 W which can not be replaced
 - Lifetime * of LEDs: 50,000 hours
 - Illuminance of 1100 Lux at 35 cm
 - Color temperature: 3000 K / 4000 K / 6000 K
 - Weighted energy consumption: 5 kWh / 1000 h
 - Luminous efficiency ** of LEDs: 120 lm / W
 - Energy efficiency: class A / A + / A ++ (spectrum A ++ to E)
 - CRI: 81
 - 2 years warranty
 - Maximum height: 35 cm / minimum height: 25 cm
 - Materials: glass base / arms and aluminum head

* Average consumption: 1000 h / year
** Light emission of the lighting source

Réf. product	Color	Cable length	Code EAN	EA by box
400124478	Metal gray	1,5 m	3595560029433	1 pc.

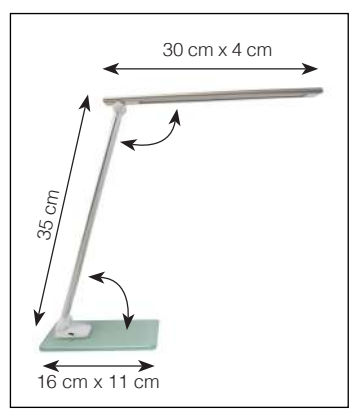

Technical features

Measurement of Lux on the worktop in 35 cm top view:

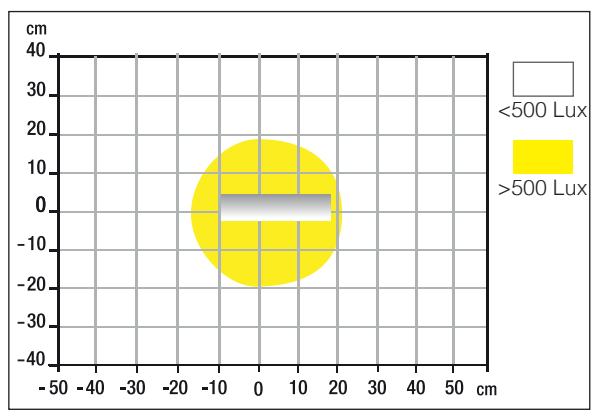

Measurement of Lux on the worktop with a 35 cm profile:

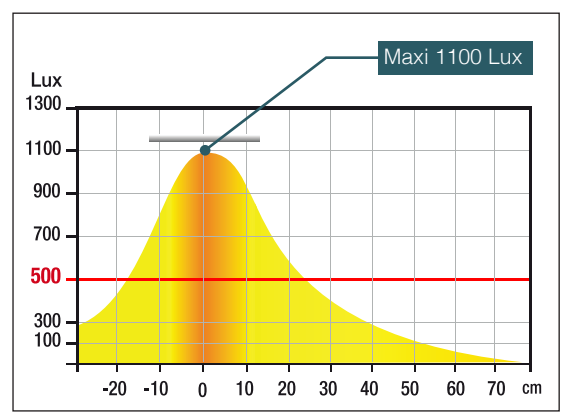

Energy class

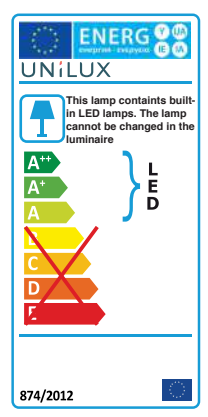



THE + PRODUCT
High battery life

- **Nomad lamp:** wireless and thanks to its low weight of 240g, NELLY is easily transported from one workspace to another (office, meeting room, co-working spaces).
- **Compact:** once folded, this lamp can now accompany you on your travels (transport).
- **High-efficiency 2400mAh Lithium-Ion battery:** it offers a battery life of 7h and can easily be recharged via its 1.2 m USB cable (supplied).
- **35 cm arm:** fully flexible swivel in all directions to adjust lighting in the right place on your worktop.
- **Light intensity variation:** by pressing the touch button continuously.
- **Variation of color temperature:** by short press on the touch button: 3000 K / 4000 K / 6000 K.
- **Protect your eyes:** this floor lamp offers a pleasant, stable, quality light thanks to the latest generation LED protected by an opaque plastic. No flicker or glare.

Nominal power: this luminaire contains integrated LED lamps with a power of

- 7,8W which can not be replaced
- Lifetime * of LEDs: 20,000 hours
- Illumination of 1100 Lux at 35 cm
- Color temperature: 3000 K / 4000 K / 6000 K
- Weighted energy consumption: 6,5 kWh / 1000 h
- Luminous efficiency ** of LEDs: 134 lm / W
- Energy efficiency: class A / A + / A ++ (spectrum A ++ to E)
- CRI: 81
- 2 years warranty
- Maximum height: 35 cm / minimum height: 25 cm
- Materials: base and head in ABS plastic / metal arm with rubber surface

* Average consumption: 1000 h / year
** Light emission of the lighting source

Réf. product	Colour	Cable length	Code EAN	EA by box
400124483	White	1,2 m	3595560029372	1 pc.

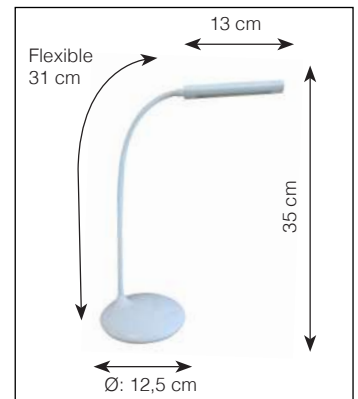

Technical features

Measurement of Lux on the worktop in 35 cm top view:

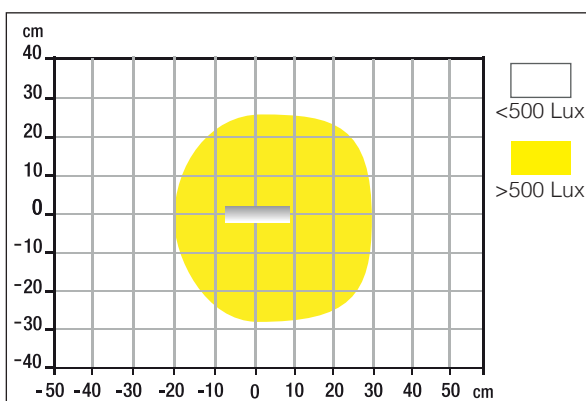

Measurement of Lux on the worktop with a 35 cm profile:

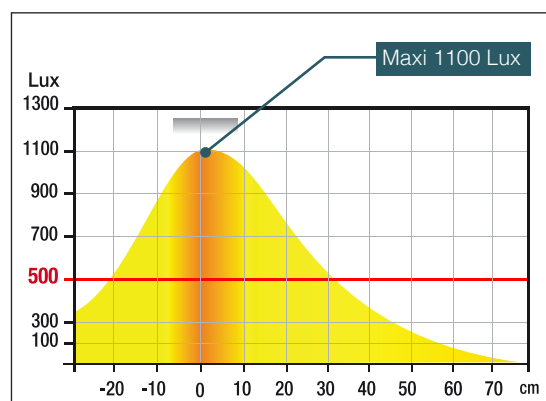

Energy class

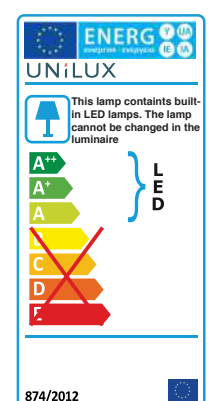

/ BATTERY LAMPS



CRISTAL



- **Decorative and technological:** this last generation lamp thanks to its TOUCH system (3 intensities), turns on and off at the touch of your finger on a metal part of the product.
- **Design and stability:** its stable pedestal and tapered lamp base at the base give it a sleek, modern look.
- **Indirect light:** lighting reflected indirectly by the lampshade, thus offering a better distribution on the work surface.
- **Quality materials:** its frosted glass basin allows for a soft and perfectly diffused lighting.

- Nominal power: this luminaire is supplied with 2 LED bulbs E14 base with a power of 2 x 5 W
- Lifetime * of LED bulb: 50,000 hours
- Illuminance of 440 Lux at 33 cm
- Color temperature: 3000 K
- Weighted energy consumption: 8,2 kWh / 1000 h
- Luminous efficiency ** of LEDs: 120 lm / W
- Energy efficiency: class A / A + / A ++ (spectrum A ++ to E)
- CRI: 82
- 2 years warranty
- Maximum height: 47 cm / minimum height: 33 cm
- Materials: painted metal base and chrome steel / frosted glass shade

* Average consumption: 1000 h / year
 ** Light emission of the lighting source

Réf. product	Color	Cable length	Code EAN	EA by box
400064642	Metal gray	2,0 m	3595560011551	1 pc.



Technical features

Measurement of Lux on the worktop in 35 cm top view:

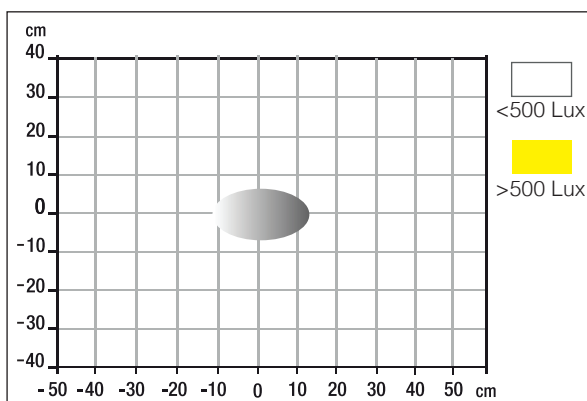

Measurement of Lux on the worktop with a 35 cm profile:

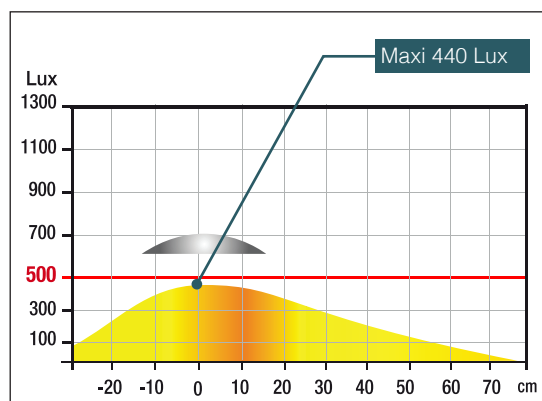

Energy class

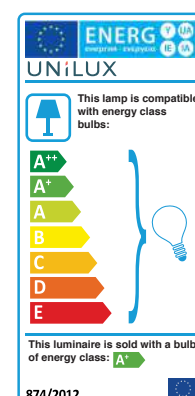



/ INCLINEA



- **Tilt Adjustment:** A handle that allows the lamp to tilt to move light onto the work surface.
- **Trendy design:** designed in high quality brushed steel, ideal for reception desks.
- **Low visual stress after prolonged use:** ideal for working, reading or studying, at home or in the office.
- **ON / OFF switch:** easy to access on the cord

- Nominal power: this luminaire is supplied with 1 led bulb E27 base with a power of 12,4 W.
- Lifetime* of the LEDs: 20,000 hours
- Illuminance of 310 Lux at 35 cm
- Color temperature: 3000 K
- Weighted energy consumption: 10,3 kWh / 1000 h
- Luminous efficiency ** of LEDs: 120 lm / W
- Energy efficiency: class A / A + / A ++ (spectrum A ++ to E)
- CRI: 82
- 2 years warranty
- Maximum height: 65 cm / minimum height: 52 cm
- Materials: brushed steel base and arms / laminated fabric lampshade

* Average consumption: 1000 h / year
 ** Light emission of the lighting source

Réf. product	Color	Cable length	Code EAN	EA by box
400032358	Steel brushed	2,0 m	3595560005536	1 pc.



Technical features

Measurement of Lux on the worktop in 35 cm top view:

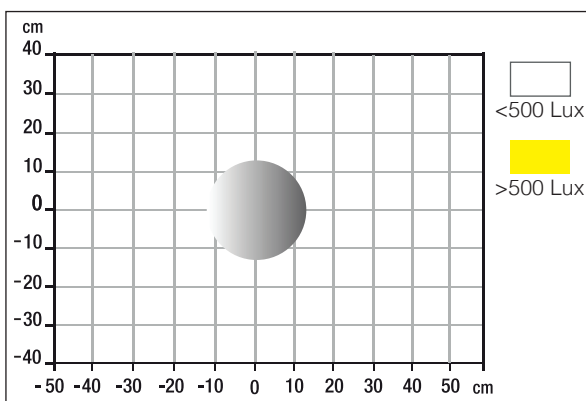

Measurement of Lux on the worktop with a 35 cm profile:

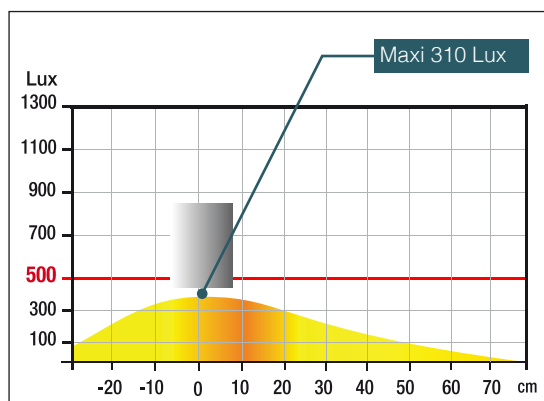

Energy class

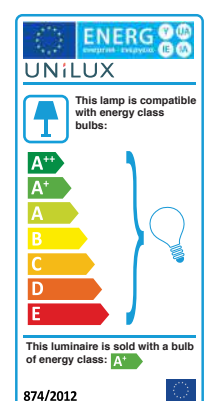

/ ROMY 

- **Indirect light:** lighting reflected indirectly by the lampshade, thus offering a better distribution on the work surface.
- **Classic design:** its reassuring shapes and sleek design allow it to integrate perfectly with any type of desktop universe and appeal to a large number of users.
- **Low visual stress after prolonged use:** ideal for working, reading or studying, at home or in the office.
- **Robustness:** lamp all metal, with beautiful finishes.
- **ON / OFF switch:** easy to access on the cord.
- **Protect your eyes:** this desk lamp LED provides you with quality lighting and comfortable because it is flicker-free and has no drag effect for reading, work and concentration. It is pleasant for the eyes and thus reduces the effects of fatigue.

- Rated power: this luminaire contains integrated LED lamps with a power of 12,7 W which can not be replaced
- Lifetie * of the LEDs: 20,000 hours
- Illumination of 815 Lux at 35 cm
- Color temperature: 3500 K
- Weighted energy consumption: 10,6 kWh / 1000 h
- Luminous efficiency ** of LEDs: 134 lm / W
- Energy efficiency: class A / A + / A ++ (spectrum A ++ to E)
- CRI: 82
- 2 years warranty
- Maximum height: 42 cm / minimum height: 42 cm
- Materials: Epoxy painted steel

* Average consumption: 1000 h / year
 ** Light emission of the lighting source

Réf. product	Color	Cable length	Code EAN	EA by box
400077407	Chrome	2,0 m	3595560012831	1 pc.



Technical features

Measurement of Lux on the worktop in 35 cm top view:

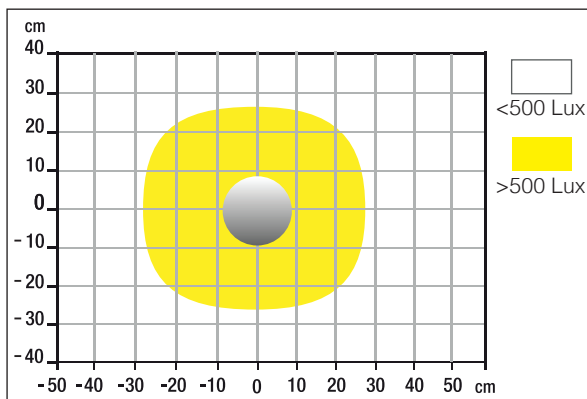

Measurement of Lux on the worktop with a 35 cm profile:

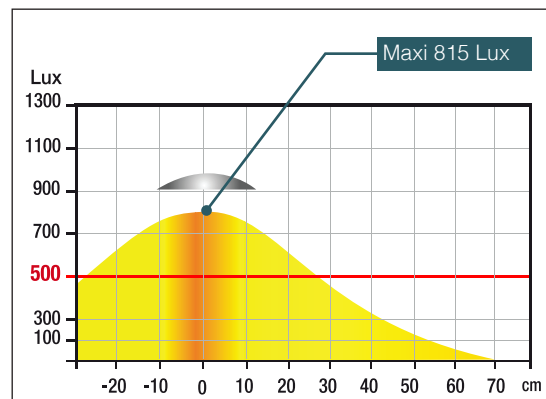

Energy class

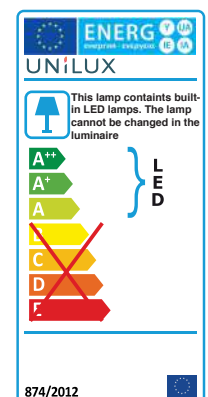



/ MAGNIFYING LAMPS



/ MINI ZOOM LED



- **Precision:** ideal for all precision work (watchmaking, microelectronics, dermatology, dental prosthesis, manicure, leisure activities). Equipped with a \varnothing 9,5cm lens of 3 diopters (x1,75), without deformation on the sides and an over-lens of 12 diopters (x7) for optimal magnification.
- **Flexibility:** its malleable swivel arm and swiveling head in all directions facilitate the orientation of the light beam.
- **Modern and practical design:** this ultra-handly technical lamp will be very useful for precision tasks such as sewing, jewelry making, and watchmaking.
- **Optimal and bright lighting:** The LED lighting of this lamp provides glare-free, uniform light that does not hurt your eyes.
- **Practical:** sold with its dust cover.
- **Available in two colors:** black or white

- Rated power: this luminaire contains integrated LED lamps with a power of 5,9 W which can not be replaced
- Lifetime * of LEDs: 50,000 hours
- Illumination of 1890 Lux at 35 cm
- Color temperature: 6700 K
- Weighted energy consumption: 4,9 kWh / 1000 h
- Luminous efficiency ** of LEDs: 130 lm / W
- Energy efficiency: class A / A + / A ++ (spectrum A ++ to E)
- CRI: 82
- 2 years warranty
- Maximum height: 35 cm / minimum height: 25 cm
- Materials: base, arm and head made of ABS plastic / equipped with a glass lens

* Average consumption: 1000 h / year
 ** Light emission of the lighting source

Réf. product	Color	Cable length	Code EAN	EA by box
400108074	White	1,8 m	3595560027699	1 pc.
400110245	Black	1,8 m	3595560028122	1 pc.

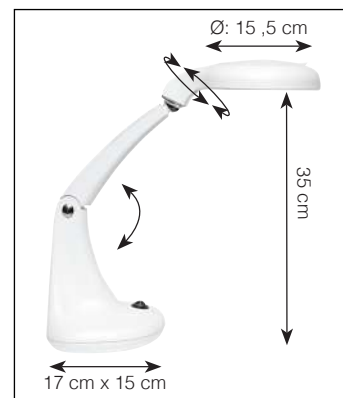

Technical features

Measurement of LUX on the worktop in 35 cm top view:

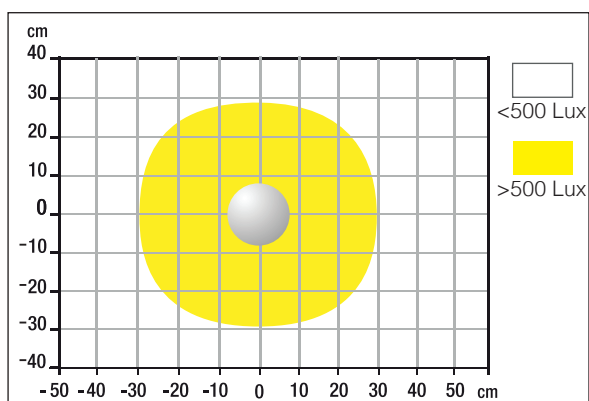

Measurement of LUX on the worktop with a 35 cm profile:

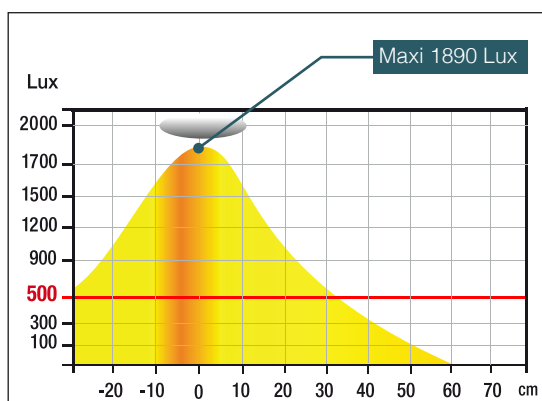

Energy class

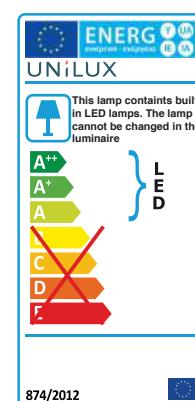

/ ZOOM LED



- **Accuracy:** ideal for all precision work (watchmaking, micro electronics, dermatology, dental prosthesis, manicure, leisure activities). Magnification up to 1.75 (3 diopters) without deformation.
 - **Flexibility:** very malleable thanks to its double pivoting arm with double articulation, equipped with compensation and its adjustable head in all directions, facilitate the orientation of the light beam.
 - **Optimal and bright lighting:** The LED lighting of this lamp provides glare-free, uniform light that does not hurt your eyes.
 - **Practical:** sold with its dust cover.
- Rated power: this luminaire contains integrated LED lamps with a power of 7,7 W that can not be replaced
 - Lifetime* of LEDs: 50,000 hours
Illumination of 1950 Lux at 35 cm
 - Color temperature: 6200 K
 - Weighted energy consumption: 6,4 kWh / 1000 h
 - Luminous efficiency ** of LEDs: 100 lm / W
 - Energy efficiency: class A / A + / A ++ (spectrum A ++ to E)
 - CRI: 83
 - 2 years warranty
 - Maximum height: 35 cm / minimum height: 25 cm
 - Materials: base, arm and head made of ABS plastic / equipped with a glass lens
 - * Average consumption: 1000 h / year
 - ** Light emission of the lighting source

Réf. product	Color	Cable length	Code EAN	EA by box
400108073	White	1,8 m	3595560027682	1 pc.

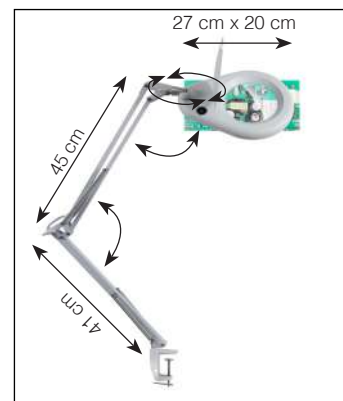

Technical features

Measurement of LUX on the worktop in 35 cm top view:

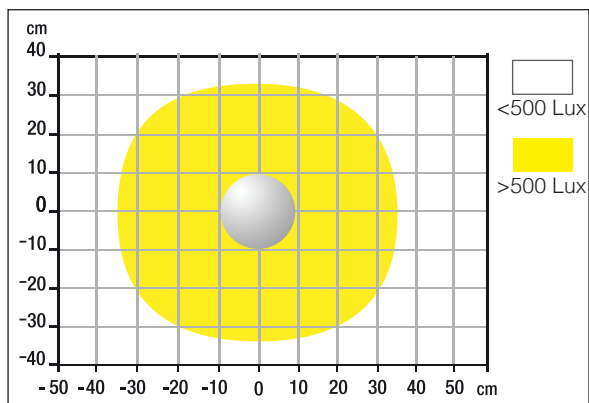



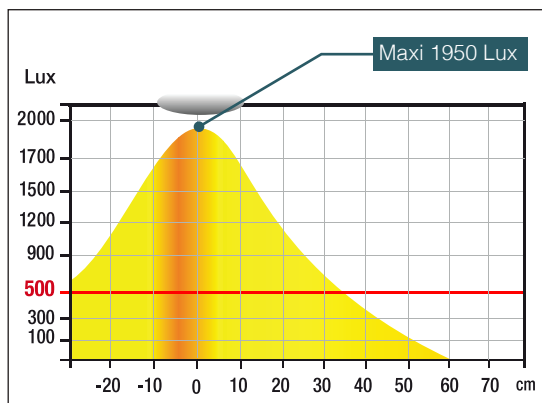



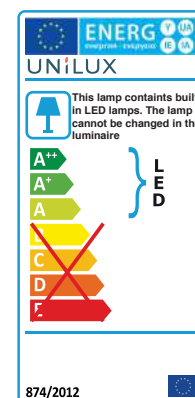















Measurement of LUX on the worktop with a 35 cm profile:

















Energy class













-  ON/OFF
-  Rechargeable battery
-  Wireless charger
-  Tactile variation of intensity
-  Automatic switch OFF
-  USB port
-  Color temperature adjustable
-  Light sensor
-  Asymmetric lighting
-  Application "My unilux"

LAMPS	Color	SAP no.	ON/OFF	Tactile variation of intensity	USB port	Color temperature adjustable	Rechargeable battery	Wireless charger	Asymmetric lighting	Automatic switch OFF	Light sensor	Application "My unilux"	EAN code	Page
 SOL	Black	400077402	●										3595560012794	p 55
	White	400077404		3595560012800										
	Red	400077406		3595560012824										
	Blue	400077405		3595560012817										
 FLEXIO 2	Black	400093687	●										3595560014750	p 54
	Metal gray	400093692		3595560014781										
	Green	400093694		3595560014941										
	Blue	400093695		3595560015382										
 RUMBALED	Black	400093720	●										3595560015443	p 65
 SUCCESS 66	Black 66	400093600	●										3595560014552	p 64
	Black 80	400093579		3595560014613										
	White 80	400093610		3595560014644										
 SUCCESS 80 chrome	Chrome	400092123	●										3595560014255	p 63
 MAMBOLED	Black	400033683	●										3595560005796	p 60
	Metal gray	400033684		3595560005802										
 DISC	Black/ metal gray	100340421	●										3595560014859	p 44
 BRIO 2	Black	400093669	●										3595560014736	p 41
 DUO LED	Black	400093984	●										3595560020874	p 36
 ROMY	Chrome	400077407	●										3595560012831	p 77
 INCLINEA	Brushed steel	400032358	●										3595560005536	p 76
 MINI ZOOM LED	White	400108074	●										3595560027699	p 80
	Black	400110245		3595560028122										

LAMPS	Color	SAP no.	ON/OFF	Tactile variation of intensity	USB port	Color temperature adjustable	Rechargeable battery	Wireless charger	Asymmetric lighting	Automatic switch OFF	Light sensor	Application "My unilux"	EAN code	Page
 ZOOM LED	White	400108073	●										3595560027682	p 81
 TERRA	Metal gray	400077409	●	●									3595560012855	p 70
 ULVA	Metal gray	400012753	●	●									3595560000128	p 51
 JOKER halogène	Black	100340174	●	●									3595560002672	On the website
 JOKERLED	Black	400064432	●	●									3595560011353	p 43
	Metal gray	400064434											3595560011377	
	Green	400064435											3595560011391	
	Purple	400064436											3595560011384	
 URBAN	Black	400093963	●	●									3595560017782	p 45
 SWINGO LED	Black	400093838	●	●									3595560016485	p 59
	White	400093839											3595560016570	
 ILLUSIO	Black	400036264	●	●									3595560006519	p 40
 CRISTAL LED	Metal gray	400064642	●	●									3595560011551	p 75
 EASY	Black	400093833	●	●	●								3595560015580	p 52
 VICKY	White/ beech	400110084	●	●	●								3595560028139	p 49
 POPY	Metal gray	400124478	●	●		●							3595560029433	p 71
 LUCY	White	400093614	●	●		●							3595560014675	p 53
	Black	400093640											3595560014705	
 SENZA 2	Metal gray	400092054	●	●		●							3595560014286	p 58
 JACK	Black	400077430	●	●	●	●							3595560012862	p 50

Features

-  ON/OFF
-  Rechargeable battery
-  Wireless charger
-  Tactile variation of intensity
-  Automatic switch OFF
-  USB port
-  Color temperature adjustable
-  Light sensor
-  Asymmetric lighting
-  Application "My unilux"

LAMPS	Color	SAP no.	ON/OFF	Tactile variation of intensity	USB port	Color temperature adjustable	Rechargeable battery	Wireless charger	Asymmetric lighting	Automatic switch OFF	Light sensor	Application "My unilux"	EAN code	Page
 NELLY	White	400124483	●	●		●	●						3595560029372	p 73
 LINKA	Black	400124484	●	●	●	●		●					3595560029402	p 67
 DIVA	Black	400124560	●	●	●	●		●					3595560029495	p 47
 JAZZ	White/ metal gray	400093836	●	●	●	●		●			●		3595560016327	p 69
 FOLIA	Black	400020346	●	●					●	●			3595560002856	p 39
	White	100340438											3595560016174	
 ERGOLIGHT	Black	100340991	●	●					●	●			3595560021092	p 38
 SENSATION	Black	100340449	●	●					●	●			3595560015573	p 37
 MAGIC	Black	400016681	●	●					●	●			3595560002238	p 57
 STRATA	Black	400124562	●	●		●			●		●		3595560029525	p 35
 SUNLIGHT	Black	400110128	●			●						●	3595560028030	p 33
 EYELIGHT	Black	400093835	●	●		●						●	3595560015672	p 32
	Metal gray	400095547											3595560026005	
 TIMELIGHT	Black	400110241	●	●	●	●		●				●	3595560028085	p 31

/UNILUX's advice:

How to position your lamp?

The individual backup lamp is an important element of improving visual comfort. A few simple rules to take full advantage of its effects :

- Position the lamp head at least 35 cm above the worktop
- Place the lamp on the opposite side of the hand that writes
- Focus on asymmetric lighting for computer work
- Position the lamp for easy adjustment and bring the light to the right place
- Avoid reflections on glossy surfaces

Prevent eyestrain

The presence in the visual field of alternatively too dark and too light areas causes the contraction of muscles around the eye and the variation of the diameter of the pupil.

This is the most important factor of visual eye strain. The eye is a muscle and fragile organ that must be managed.

To reduce this eye strain, it is advisable to take breaks and orthoptic exercises. One of them is to fix the tip of a pencil or a fixed point on a smartphone that moves without moving the head. This has the effect of relaxing the eye muscles.

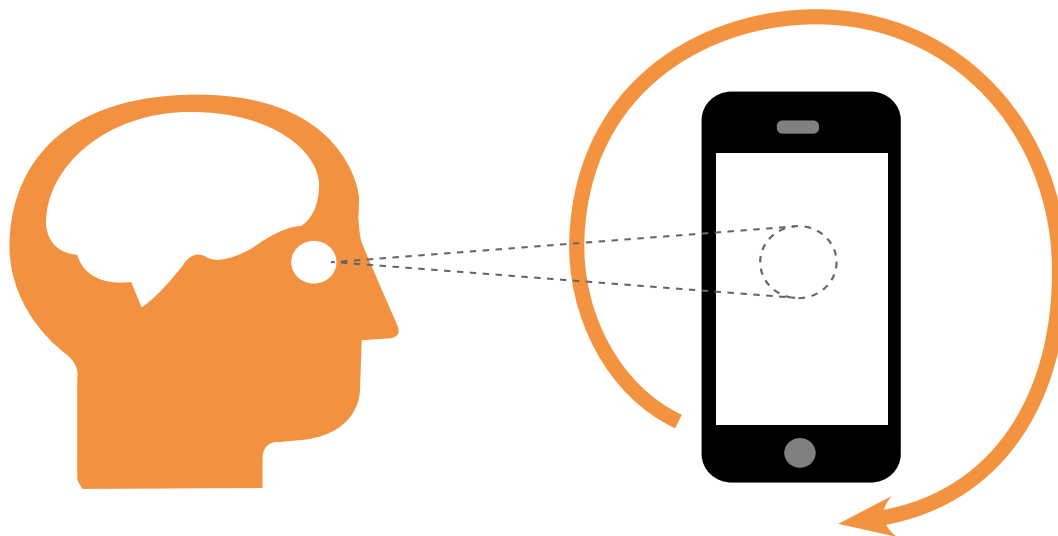



1

Relieve cervical tension

PROBLEMS

Tension in the neck, pains in trapezius

CAUSES

- Screen position too low
- No possibility of adjustments

SOLUTIONS

- SUPPORT AND SCREEN ARM
p 92 to p 94

2

Avoid wrist pressure

PROBLEMS

tingling, tensions in the arms

CAUSES

- Nerve pressure carpal
- Bad posture arm

SOLUTIONS

- WRIST REST
p 95

3

Improve blood circulation

PROBLEMS

Heavy legs, tingling

CAUSES

- Poor blood circulation
- Poorly positioned foot position

SOLUTIONS

- FOOTRESTS
p 96 to p 101

4

Energize workspaces

PROBLEMS

Back pain and legs, tiredness

CAUSES

- Sit still long hours without moving or get up

SOLUTIONS

- STATION SITTING / STANDING
p 102 to p 105

/Responses to musculoskeletal disorders

Muscular Skeletal Disorders (MSDs)

MSDs: 1st occupational disease in France, set of pain in the muscles and tendons that cause troublesome pain (numbness, tingling, ...). These diseases cause a serious handicap in everyday life.

Main MSDs :

- 1- Cervicalgia
- 2- Carpal tunnel syndrome
- 3- Low back pain
- 4- Tendinitis of the shoulder and elbow
- 5- Calf pain

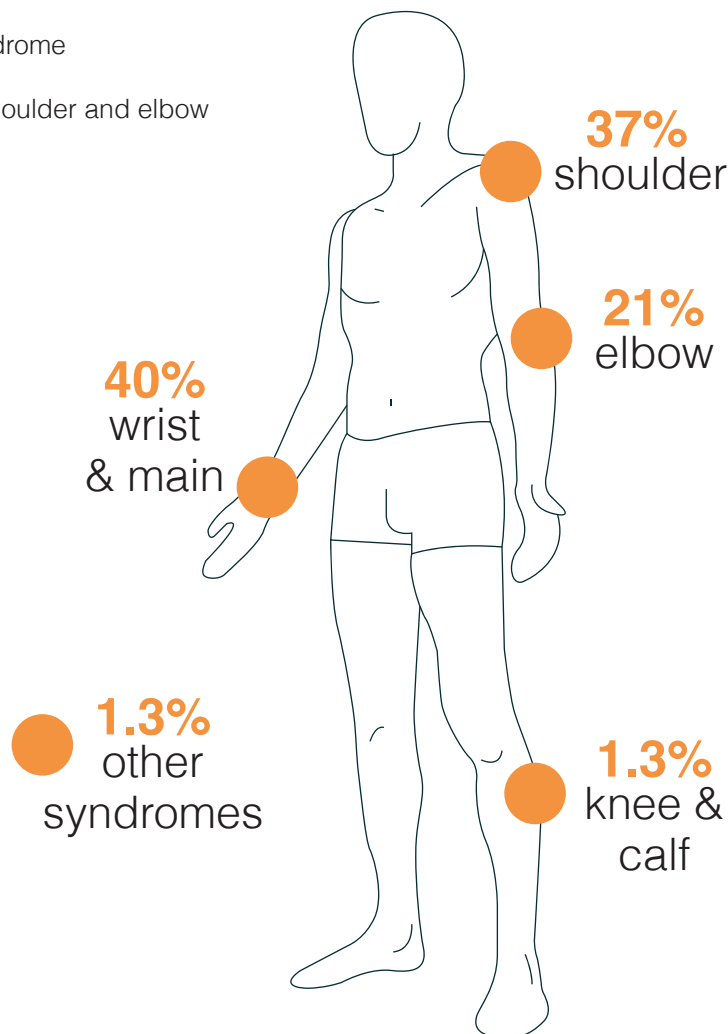

Neck pain

Set of pains felt in the neck, from the upper back to the neck. It is often caused by poor posture, prolonged use of the computer, or by stressing an upper body muscle caused by poor posture.

Carpal tunnel syndrome

Trouble related to compression of the median nerve as it passes through the carpal tunnel at the wrist. This nerve allows movements of the hand and wrist, if it is compressed (it is often caused by repetitive gestures = mouse clicks for example), the nerve impulse is difficult to pass.

Low back pain

Commonly referred to as "back pain", "lumbago" or "backache", is pain located in the lumbar vertebrae. It can go down to the buttocks, even to the back of the knee. This is the leading cause of disability before the age of 45.

Tendonitis

Inflammation of a tendon (tape connecting a muscle to a bone) mainly in the elbow and shoulders causing acute pain related to several causes. There are different tendonitis (shoulder, elbow, ...). His healing is long.

The symptom of heavy legs:

Unpleasant sensations such as tingling, numbness, tingling or burning up to a feeling of pain in the legs. They are linked to a poor circulation of blood in the veins.

Tips for good posture

A good working posture saves both productivity for the company and comfort and safety for employees. It is for these reasons that UNILUX designs products with functional, ergonomic concepts and harmonious and bold design. Some tips for diagnosis work posture:

- Using a footrest to raise the foot 15 °.
- The angle of the elbow must be 90 ° or slightly obtuse.
- The forearms are close to the body and rest on the armrests.
- The hand should be in the extension of the forearm and supported by a wrist rest.
- The back is straight or slightly behind, and supported by the backrest.
- The head is straight or slightly bent forward.
- The top of the screen is at eye level.
- The work plan should preferably be matte.

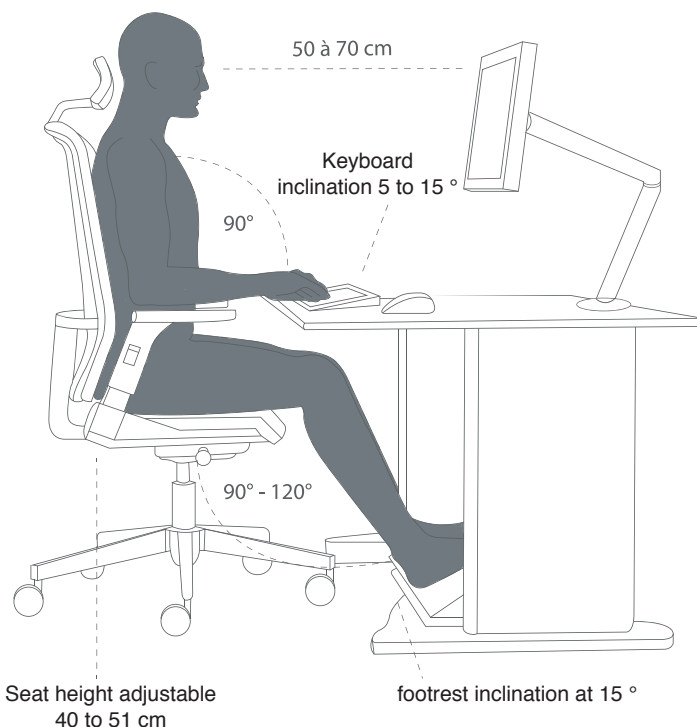

In 92% of the companies, the employees set up themselves emergency solutions to overcome the lack of ergonomics workstations.

The results

MSDs are the most common occupational health problem in all industries.

Since 2013, the number of MSDs has increased by more than 60% in France *. One in three employees had to stop working for health problems related to poor work posture, with an average of 22 days * sick leave.



8 in 10 French people say they have suffered pain



8 millions work stoppages due to the TMS **



800 M € annual cost ***

A major challenge for public health and productivity
for French companies

* and ** Source: Health Insurance (2015)

*** Source: CRAMIF (2016)

/How to fight against sedentary lifestyle?

European employees spend an average of 7 hours sitting in front of their computers, which represents 60% of the working time.

94% of them admit to sitting without moving for several hours. The human body is designed to “move” and not to remain in a static position, which decreases the oxygenation of the body and which:

- Slows down our metabolism
- Increases risk of cardiovascular disease
- Develops fat cells and a potential overweight
- Causes continual general fatigue

Sedentary



1st cause of death
in tobacco in OECD
countries



48%
increase in diabetes,
hypertension
and obesity



40%
of increased risk
of cardiovascular
disease

What the law says?

Companies are required to carry out risk audits of workstations: DIRECTIVE EC 90/270 / EEC. They must ensure safety, protect the physical and mental health of their employees and guarantee them a safe and comfortable workstation (Article L4121-1 to -5 of the Labor Code).



European directive
Obligations to the employer
to guarantee the safety
and health of employees
Directive 9.0 / 270 / EEC of
29/05/1990



Health insurance
provides assistance up to
€ 25,000 for any company
wishing to take
a precautionary approach **



The Labor Code
imposes the provision
an employee footstool
who request it
Article R.4542-9

The UNILUX solution: our wide range of ergonomic accessories

To fight against MSDs and sedentary lifestyle, it is necessary to move more, while being able to be productive in the tasks entrusted to us. Sit-stand solutions give you the opportunity to energize your workday. It is for all these reasons that UNILUX offers you a wide range of ergonomic accessories ranging from the footrest to the booster seat to a dynamic stool and a sit / stand workstation.

Being more active has become a societal issue. A first goal would be to spend at least 2 hours a day while standing at work and then try to reach an ideal duration of 4 hours.



MOOVE



ERGO DESK 2



ERGO WELL



UPDOWN

The benefits

- Improves blood circulation
- Increase concentration
- Decrease the feeling of tiredness
- Limit stress and weight gain

Save your employer money

A person with a TMS costs the company an average of 21500 € *. But the lack of ergonomics of a workstation can have a negative impact on the productivity of the employees and the finances of the company. Today, to attract and retain employees, companies must make efforts on the proposed working conditions and invest to improve the well-being of their employees.

Average cost of a TMS for an employee



21 500€*

Average cost of a complete equipment

1250€

- 35 € footrest
- 20 € wrist rest
- 100 € screen arm support
- 200 € ergonomic chair
- 200 € ergonomic stool
- 700 € electric office

That is an economy per employee of about



20 250€

* Source: CNAMTS CCMSA - 2010 figure
** Source: tmspro.fr

/ERGO ONE



- **Health and well-being:** This easy-to-use, ergonomic arm improves your posture and relieves your cervical vertebrae by adjusting the screen at a distance, height and angles to suit your needs.
 - **Performance at work:** the use of this double arm screen disencumbra your workspace and boost your work by promoting collaborative work.
 - **Flexibility:** this multi-directional monitor arm (horizontal / vertical display) is equipped with a gas spring, it fits effortlessly and keeps your screen with a perfect viewing angle.
 - **The + product:** equipped with 2 USB 3.0 ports, easy access to the base, ideal for sharing data from a USB key and to charge your typical devices smartphones and tablets.
 - **Optimum ergonomic space:** the use of ergonomic monitor-support arm makes the work more pleasant, it is a valuable asset for a healthy place. Ergonomic comfort at work begins with the correct height of the monitor.
 - **Modern and ergonomic design:** this aluminum arm support, black color, will perfectly integrate your individual or open-space offices.
 - **Convenient:** The integrated cable management system makes your workspace neat and tidy without any cables in sight.
 - **Quick and easy installation:** with its robust desktop type vise clamp to be fixed behind the desk for maximum amplitude (max spacing: 8 cm).
- Quick fixing system of the screen on the arm support
 - 360 ° rotation for landscape or portrait views
 - Tilt and easily extendable up to 40 cm max. and forward to 44 cm max.
 - Capable of supporting a screen up to 32 "with a maximum weight of 8 kg.
 - VESA Standard *: Suitable for screens with VESA mounting holes 75 mm x 75 mm or 100 mm x 100 mm.
 - Materials: aluminum arm and base / ABS plastic cable gland

* Video Electronics Standards Association, aims to define a normality between all brands of flat screens to allow you to choose your support in relation to the size of your screen.

Réf. product	Color	Warranty	Code EAN	EA by box
400124578	Black	2 years	3595560029822	1 pc.



Technical features

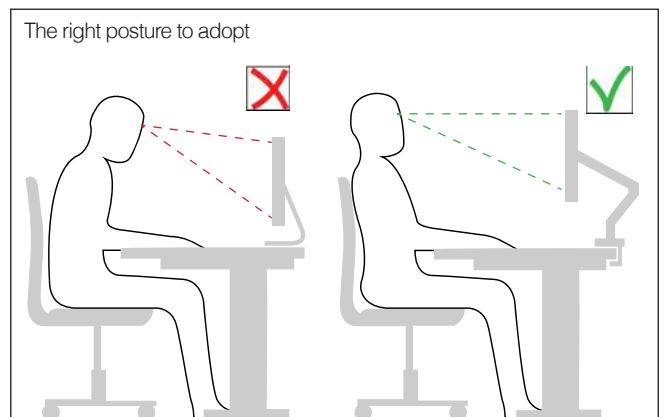
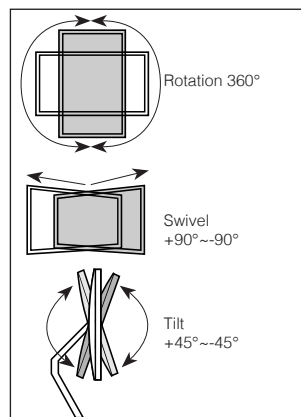
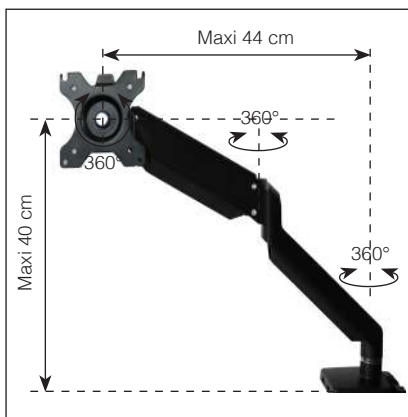

/ERGO TWIN



- **Health and well-being:** This easy-to-use, ergonomic arm improves your posture and relieves your cervical vertebrae by adjusting the screen at a distance, height and angles to suit your needs.
 - **Performance at work:** the use of this double arm screen disencumbra your workspace and boost your work by promoting collaborative work.
 - **Flexibility:** this dual-arm multidirectional display arm (horizontal / vertical display) is equipped with a gas spring, it fits effortlessly and keeps your screen with a perfect viewing angle.
 - **The + product:** equipped with 2 USB 3.0 ports, easy access to the base, ideal for sharing data from a USB key and to charge your typical devices smartphones and tablets.
 - **Optimum ergonomic space:** the use of ergonomic monitor-support arm makes the work more pleasant, it is a valuable asset for a healthy place. Ergonomic comfort at work begins with the correct height of the monitor.
 - **Modern and ergonomic design:** this aluminum arm support, black color, will perfectly integrate your individual or open-space offices.
 - **Convenient:** The built-in cable management system makes your workspace neat and tidy without any cables in sight.
 - **Quick and easy installation:** with its robust desktop type vise clamp to be fixed behind the desk for maximum amplitude (max spacing: 8 cm).
- Quick fixing system of the screen on the arm support
 - 360 ° rotation for landscape or portrait views
 - Tilt and easily extendable up to 40 cm max. and forward to 44 cm max.
 - Capable of supporting 2 screens up to 32 "(maximum weight of 8 kg per screen)
 - VESA Standard *: Suitable for screens with VESA mounting holes 75 mm x 75 mm or 100 mm x 100 mm.
 - Materials: aluminum arm and base / ABS plastic cable gland

* Video Electronics Standards Association, aims to define a normality between all brands of flat screens to allow you to choose your support in relation to the size of your screen.

Réf. product	Color	Warranty	Code EAN	EA by box
400124579	Black	2 years	3595560029853	1 pc.



Technical features

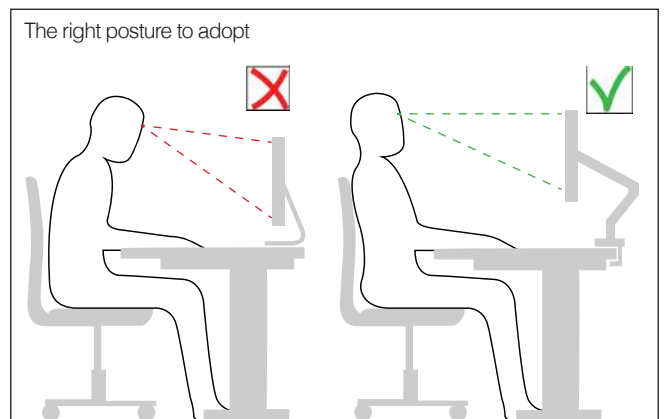
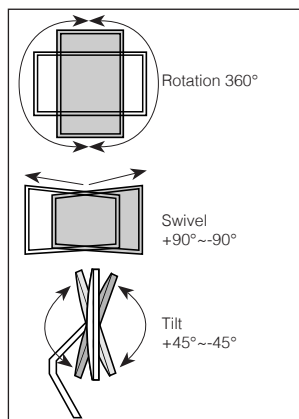
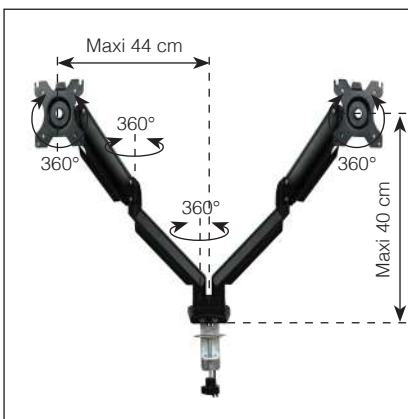

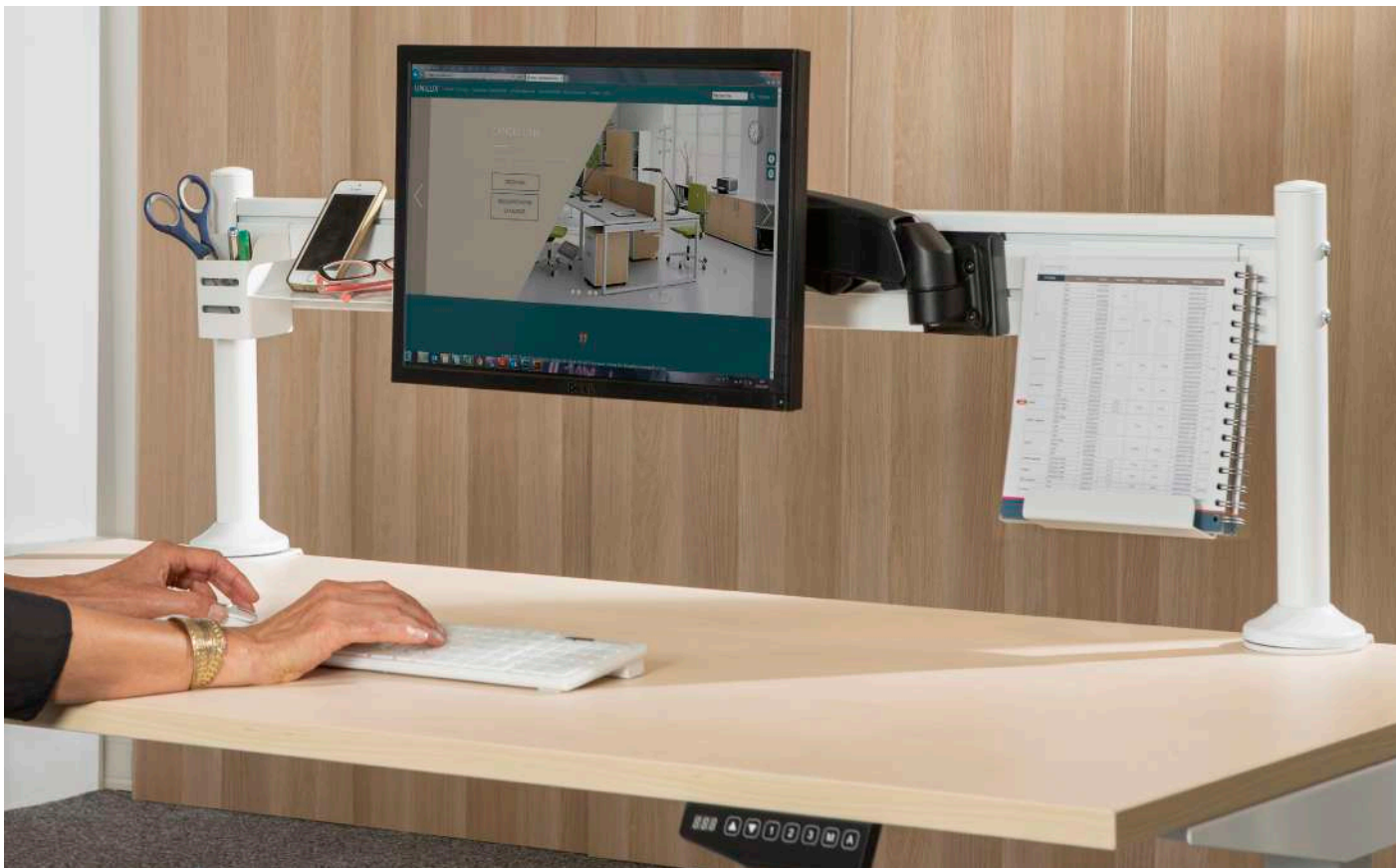

/ERGO STATION



- **Health and well-being:** composed of an easy-to-use ergonomic monitor-support arm, it improves your posture and relieves your cervical vertebrae thanks to the adjustment of the screen at a distance, a height and angles in according to your needs.
- **Structured Desk:** This versatile ergonomic desktop organizer has storage space such as a vertical A4 stand, a cell phone slot, and a pen holder. The space thus released on your desk helps to bring you a better organization in your work.
- **Flexibility:** Equipped with a gas spring, it fits effortlessly and keeps your screen with a perfect viewing angle. It is able to rotate 360 ° for landscape or portrait view, tilt and is easily extendable up to 45 cm max. and forward to 42 cm max. Design "well-thought": the combination of aluminum and steel allows it to integrate any style of workspace.
- **The + product:** with a maximum length of 125 cm it will easily adapt to any type of office from 140 - 160 - 180 cm wide.
- **Quick and easy installation:** with two robust desktop clamps type vise to be fixed behind the desk for maximum amplitude. A thickness of office is suggested = 1 to 5 cm (supplied with an Allen key)

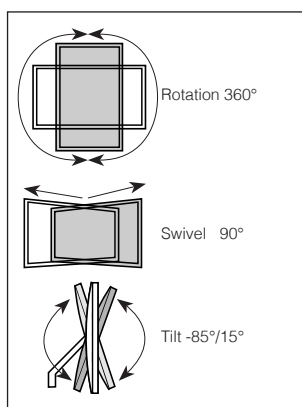

- Supports a screen weighing up to 7 Kg and size up to 27 "
- Dimensions: width: 125 cm / height: 40 cm
- VESA * standard: Suitable for a screen with VESA mounting holes 75 x 75 mm or 100 x 100 mm.
- Materials: aluminum frame / accessories in high quality steel with Epoxy paint finish.

* Video Electronics Standards Association, aims to define a normality between all brands of flat screens to allow you to choose your support in relation to the size of your screen.

Réf. product	Color	Warranty	Code EAN	EA by box
400124600	White	2 years	3595560029884	1 pc.



/ROLLING



- **Health and well-being:** Limit carpal tunnel disorders with perfect wrist support.
- **Definition:** Carpal tunnel syndrome refers to disorders associated with compression of the median nerve during its passage through the carpal tunnel at the wrist.
- **Symptoms:** tingling, tingling, progressive numbness, feeling of electric shock in the tip of the first three or four fingers of the hand, or sometimes ascending to the forearm.

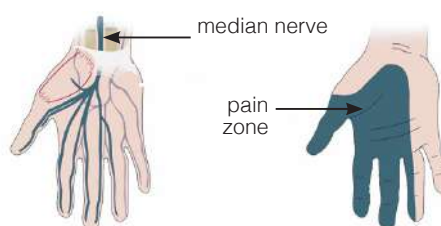

Every year in France, **just over 130,000 people** are operated on for this syndrome

- **Technical:** memory foam to support the wrist and keep the wrist in a comfortable position.
- **Mobile:** 4 ball bearings on the underside allow you to move your wrist at will and also reduce friction to protect your wrist.

- Light weight: 0.06 Kg
- Dimensions: 12 cm x 11 cm x 4 cm
- Materials: ABS / memory foam cellulose / stainless steel balls.



Use only on a laminate desk or mouse pad

Réf. product	Color	Warranty	Code EAN	Ea by box
400110158	Black	2 years	3595560028061	1 pc.

/Footrest: did you know?

Why use a footrest?

You have to define your needs. That's why we advise you on the elements to take into account to choose the ergonomic footrest. An ergonomic footrest is to be considered at the same level as ergonomic mice or ergonomic stools. The use of a footrest is really necessary. People will compensate for the fact that they do not touch the ground by an inappropriate and inappropriate position. Thanks to the footrests, these people will be in contact with the ground, feet flat and knees at the right angle of 90 °.

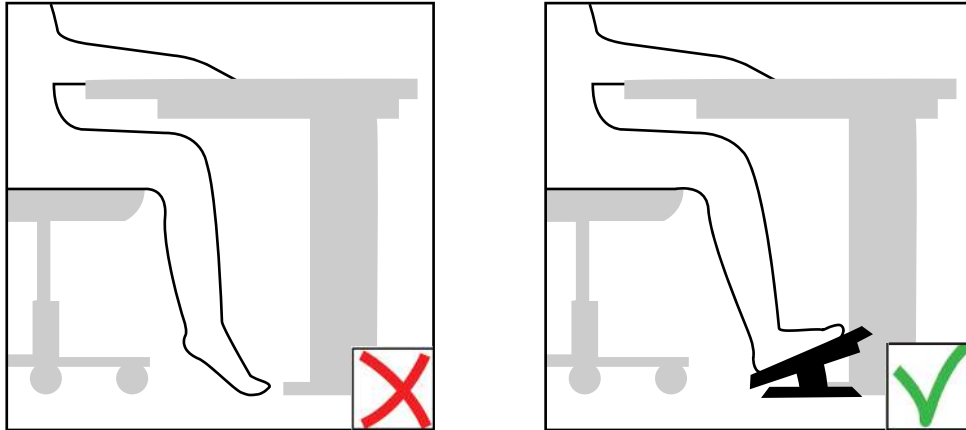

A wide range of footrests :

Ergonomic footrests are another element of ergonomic products. They become more and more indispensable in the daily life of a person who spends time sitting at his workstation. Our range of office footrests has been developed based on the ISO 9241-5 * standard for ergonomic workstation requirements. We offer 3 types of footrests so you can find the right footrest for your budget and use.

- **Inclined footrest (p 97 to p 98)**

They have a fixed or adjustable inclination to avoid any inconvenience at the ankles and allow a tilt of about 15 °. Then they must also allow a good freedom of movement of the legs and not be too bulky.

- **Height-adjustable rocker footrest (p 99)**

This type of footrest provides the freedom to tilt the tray as desired allowing a rocking movement that ensures good blood circulation. Moreover the possibility of adjusting the height according to the morphology of the person who uses it makes it possible to put the angles of the joints of the lower limbs in a position of comfort and relaxes the whole lower part of the body. Our adjustment systems are simple and easy to access. Finally all our footrests are also equipped with pads located under the structure ensuring its stability once placed on the ground, regardless of the coating of the room.

- **Dynamic footrest (p 100 and p101)**

Our body is made to move. When we remain motionless for long periods of time, our body begins to hurt. To counteract the effects of a sedentary lifestyle, it is recommended that clerks alternate positions. Each light movement of your feet will be accompanied by these footrests. The muscles participate and rebalance your body. Each of these movements will increase your muscle tone, reduce muscle tension and increase your circulatory function.

* ISO 9241-5: Workstation layout and postural requirements



/CONFORT MASSANT



- **Optimum comfort:** whatever the size of your feet, this support allows an excellent ergonomic position, guaranteeing the comfort of the back, the neck, the shoulders and the legs by assuring the adoption of a good posture.
- **Well-being:** it is equipped with a soft round PVC massage surface to relieve tired feet and pressure points.
- **At work or at home:** this ergonomic footrest is the ideal accessory that will be your ally in your daily work.
- **Anti-slip:** rubber pads, anti-slip prevents the footrest from slipping on all types of floors.

- Tilt: 10 °
- Height: front 3 cm / rear 12 cm
- Weight: 1.32 Kg
- Dimensions of the area to lay feet: 45 cm x 30 cm
- Dimensions: 45 cm x 30 cm x 12 cm
- Materials: ABS plastic structure / non-slip PVC glides



Réf. product	Color	Warranty	Code EAN	Ea by box
100340817	Black	10 years	3595560001194	1 pc.

/ORIGIN



- **Comfort:** adjustable footrest which raises the legs avoiding tension in the back, shoulders and neck ensuring a good position of the spine.
- **Well-being:** it is equipped with a round massage pimple surface to relieve tired feet and pressure points.
- this footrest adapts to the morphology of its user thanks to a system of wheel.
- **At work or at home:** this ergonomic footrest is the ideal accessory that will be your ally in your daily work.

Recommended by Occupational Medicine

- Tilt: 10 °, 15 °
- Height: front 3 cm / rear min. 11 cm max. 13.5 cm
- Weight: 1 Kg
- Dimensions of the area to lay the feet: 45 cm x 35 cm
- Dimensions: 45 cm x 35 cm x 13.5 cm
- Materials: 83% recycled material structure
-



Réf. product	Color	Warranty	Code EAN	Ea by box
100340819	Black	10 years	3595560010219	1 pc.

/CHRYSALIS



- **Comfort and well-being:** adapting to all body types, the daily use of this footrest will make you dynamic and productive at work while reducing fatigue and stress.
- **Adjustable:** in height from 10 to 13,5 cm or in inclination of 10 °, 15 °, 20 °, this footrest allows to adopt a good posture and promotes the circulation of blood.
- **At work or at home:** this ergonomic footrest is the ideal accessory that will be your ally in your daily work.
- **Anti-slip:** rubber pads, anti-slip prevents the footrest from slipping on all types of floors.

- Recommended by Occupational Medicine
- Tilt: 10 °, 15 °, 20 °
- Height: front 3 cm / rear min. 10 cm max. 13.5 cm
- Weight: 0,63 Kg
- Dimensions of the area to lay feet: 42 cm x 32 cm
- Dimensions: 42 cm x 32 cm
- Materials: ABS plastic structure / non-slip PVC glides



Réf. product	Color	Warranty	Code EAN	Ea by box
100340820	Black	10 ans	3595560009817	1 pc.

/NYMPHEA

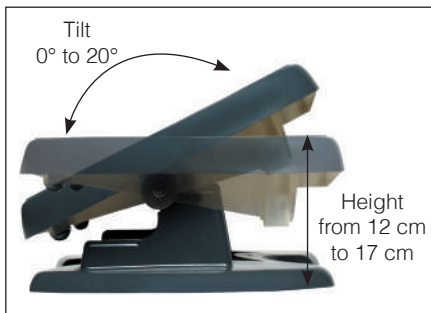

- **Comfort and well-being:** adapting to all body types, the daily use of this footrest will make you dynamic and productive at work while reducing fatigue and stress.
 - **Ergonomic:** continuously adjustable in inclination from 0 to 20 ° and height from 12 to 17cm, this footrest allows to adopt a good posture and promotes the circulation of blood.
 - **Non-slip:** its tray is equipped with a non-skid surface that keeps feet in place naturally
 - **At work or at home:** this ergonomic footrest is the ideal accessory that will be your ally in your daily work.
 - **Anti-slip:** rubber pads, anti-slip prevents the footrest from slipping on all types of floors.
- Recommended by Occupational Medicine
 - Inclination: 0 ° to 20 °
 - Height: before min. 5 cm max. 6 cm / rear min. 20 cm max. 28 cm
 - Weight: 0,97 Kg
 - Dimensions of the area to lay feet: 42 cm x 32 cm
 - Dimensions: 42 cm x 32 cm
 - Materials: ABS structure / anti-slip PVC glides



Réf. product	Clor	Warranty	Code EAN	Ea by box
100340822	Black	10 years	3595560009824	1 pc.

/CHOCOLATE

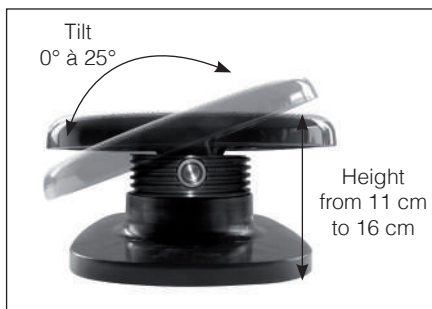

- **Comfort and well-being:** adapting to all body types, the daily use of this footrest will make you dynamic and productive at work while reducing fatigue and stress.
 - **Ergonomic:** continuously adjustable in inclination from 0 to 25 ° and in height from 11 to 16 cm thanks to its axis system in screw thread which is carried out with the feet without effort.
 - **Benefits:** Promotes blood circulation, increases productivity and decreases absenteeism.
 - **At work or at home:** this ergonomic footrest is the ideal accessory that will be your ally in your daily work.
 - **Anti-slip:** rubber pads, anti-slip prevents the footrest from slipping on all types of floors.
- Recommended by Occupational Medicine
 - Inclination: 0 ° to 25 °
 - Height: before min.4,5 cm max. 10 cm / back min. 16 cm max. 21 cm
 - Weight: 1,45 Kg
 - Dimensions of the area to lay feet: 42 cm x 32 cm
 - Dimensions: 42 cm x 32 cm
 - Materials: polypropylene plastic structure / non-slip PVC glides



Réf. product	Color	Warranty	Code EAN	Ea by box
100340816	Black	10 years	3595560015931	1 pc.



/UPDOWN



- **Fight against a sedentary lifestyle:** Our body is made to move. When we remain motionless for long periods of time, our body begins to hurt. To counteract the effects of a sedentary lifestyle, it is recommended that clerks alternate between sitting and standing.
- **An innovative footrest:** first seated feet stand-up. Its use is simple and possible almost everywhere, just place it under your feet - that's it!
- **Comfort and well-being:** guarantees the comfort of the back, neck, shoulders and legs by ensuring the adoption of a good posture.
- **At work or at home:** its light and dynamic look and ergonomic handle make this new generation footrest the essential accessory for your daily work.
- **Benefits:** Promotes blood circulation, increases productivity while reducing fatigue. It will allow you to be always moving thanks to dynamic exercises.
- **Anti-slip:** rubber pads, anti-slip prevents the footrest from slipping on all types of floors.

- Supports a weight up to 120 Kg
- Dimensions of the area to lay the feet: 45 cm x 30 cm
- Dimensions: length: 45 cm / width: 30 cm / height: 8 cm
- Materials: polypropylene plastic structure / non-slip silicone pads

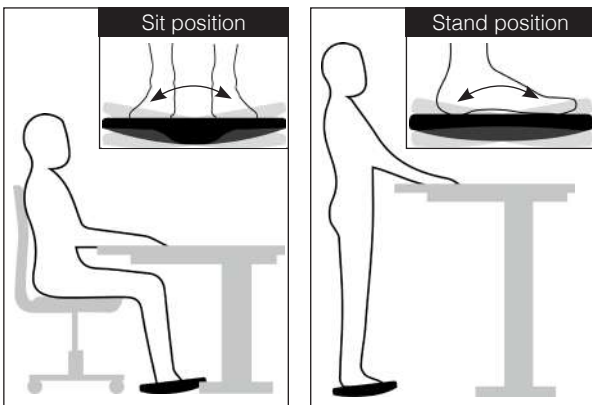

Réf. product	Color	Warranty	Code EAN	EA by box
400095456	Black	10 years	3595560025732	1 pc.



/ROLLER FEET



- **Innovative and ergonomic:** the first cylindrical foot rest inspired by the massaging roller. Its smooth part is ideal for improving your blood circulation and its multi-dimensional textured surface will allow you to benefit from the benefits of "reflexology".
- **Reflexology:** it is a therapeutic method that relieves the body by the foot. It uses the body's natural self-healing process. The foot is a miniature representation of the human body where each zone corresponds to an organ or a part of the human body.
- **Comfort and well-being:** allows a deep massage of the muscles thanks to the weight of the body. Its resistant, comfortable and structured EVA foam allows a deep and intense massage, a muscular relaxation.
- **Health benefits:** improves your balance and posture for long-term relief. He reduces muscle pain and tension underfoot.
- **Easy to use:** this new generation foot rest uses without shoes and encourages the user to reduce sedentary work by making it more dynamic. With movement back and forth with your feet, you'll be more productive, less tired and less stressed.
- **Design "massage roller":** its cylindrical shape has two surfaces, one smooth firm and resistant and the other with a pimples relief distributed along each side of its length giving the impression of feeling fingers during the massage.
- **Reliable and durable:** Designed to withstand intensive use, EVA foam is highly resistant, it will not sag under pressure.

- Supports a weight up to 120 Kg
- Dimensions: width: 44 cm / diameter: 14 cm
- Clean easily with a damp cloth and soap
- Materials: EVA foam / PVC plastic tips

 **Do not stand on it**

Réf. product	Color	Warranty	Code EAN	EA by box
400125220	Black	2 years	3595560029914	1 pc.

/MOOVE



- **Fight against a sedentary lifestyle:** the sitting position will increase the risk of having heart problems while reducing life expectancy by 7 years. Indeed, the human body is designed to “move”, and no, to remain stationary for 9 hours a day.
- **Well-being:** promotes a dynamic posture and provides great freedom of movement to adopt the correct posture without hindering movement.
- **Ergonomic:** ideal to avoid back, lumbar and muscular pain (shoulders, arms, back). Thanks to a perfect alignment of the spine, the whole body “benefits”.
- **Ergonomic and comfortable seat:** triangular padded foam seat (8 cm thick) in high density fabric for optimal comfort and well-being (width 35 cm).
- **Variable setting:** easily adjustable height (63-89cm) thanks to its gas piston system and its 3 easily accessible adjustment handles located under the seat.
- **Stability:** non-slip weighted base for better grip on different types of soil safely.
- **Complementary products:** recommended to be used with the ERGODESK 2 sitting and standing station or the ERGO WELL lift electric desk.

- Reasonable weight: 9,5 Kg
- Load capacity: can support a weight up to 150 Kg
- Materials: metal tube with epoxy paint gray metal / base in PP and rubber / fabric seat

Réf. product	Color	Warranty	Code EAN	EA by box
400110242	Black	2 years	3595560028092	1 pc.



Informations techniques

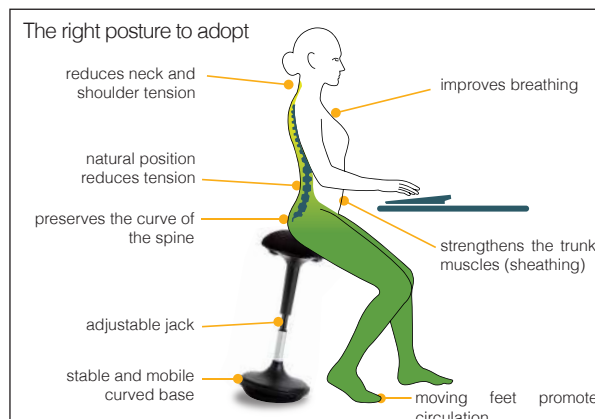





/ERGO DESK 2



- **Comfort and well-being:** Encouraging the user to reduce sedentary work and encouraging mobility, this sit-stand workstation will make you more dynamic and productive, while reducing fatigue and stress.
- **Seated task:** processing and creation of important documents (reports, schedules), paper tasks requiring concentration.
- **Standing task:** processing emails, making and receiving phone calls, online searches, proofreading and creative work.
- **Contemporary design:** this sit-stand workstation, last generation, adjustable, will energize your workspace. It adapts to all types of offices.
- **Adjustable simple and easy:** thanks to its mechanism, its cylinders and its ergonomic handle, in a few seconds you can easily change position and have different heights (between 12 and 50.5 cm) depending on your morphology
- **Easy to assemble:** a simple assembly without need for tools, its keyboard support clipable.
- **Complementary products:** recommended to use with footrest UPDOWN multi-position and MOOVE dynamic stool.

- Reasonable weight: 14,5 Kg
- Top shelf dimensions: width: 72 cm / depth: 41.5 cm
- Bottom plate dimensions: width: 72 cm / depth: 30,8 cm
- Maximum weight supported per top plate: 15 Kg
- Maximum weight supported per lower plate: 2 Kg
- Maximum height: 50.5 cm / minimum height: 12 cm
- Materials: high quality steel structure with Epoxy paint / painted wood top

Réf. product	Color	Warranty	Code EAN	EA by box
400124576	Black	2 years	3595560029761	1 pc.

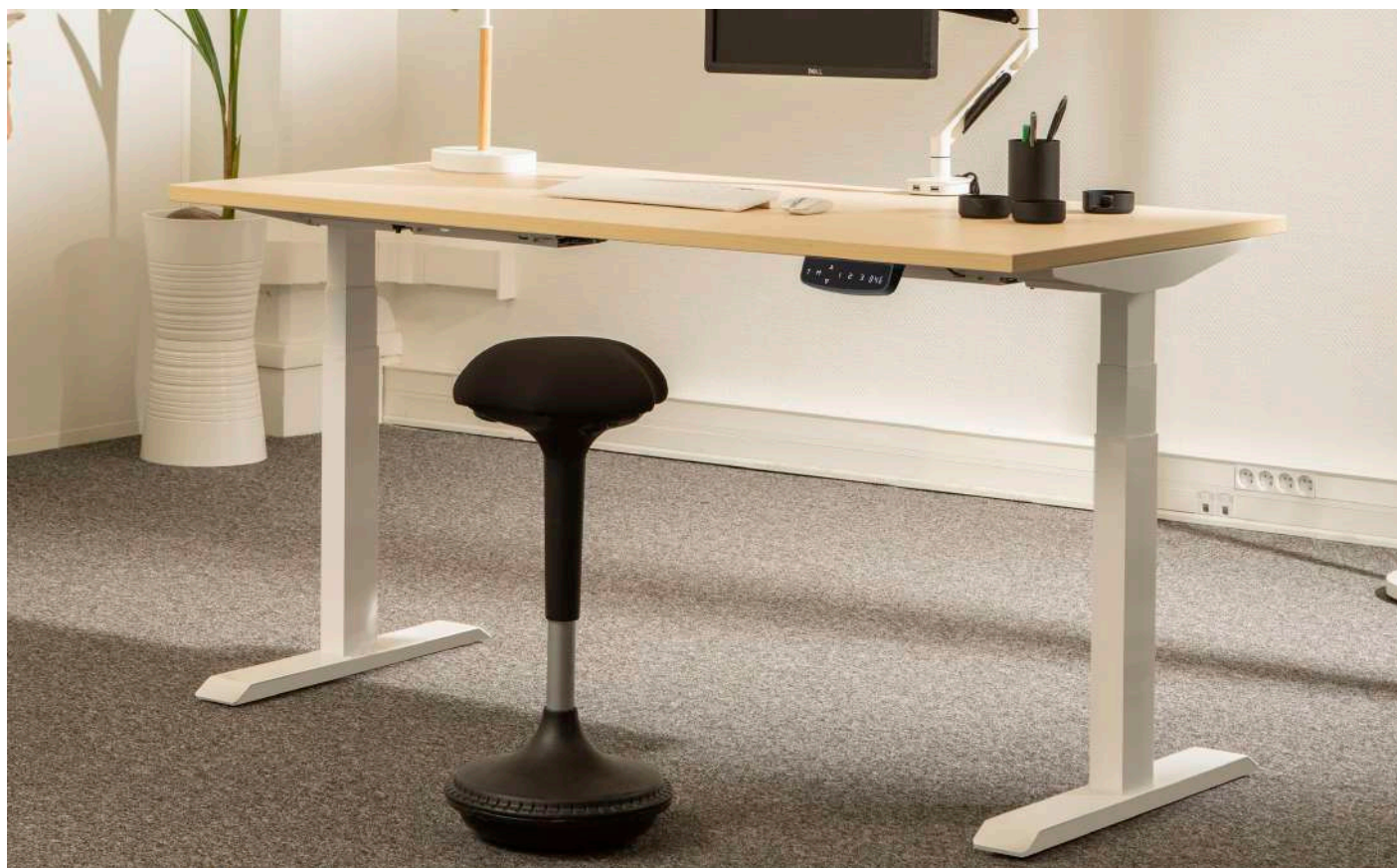

/ERGO WELL



- **Health benefits:** reduces fatigue, stress, decreases the risk of cardiovascular disease, obesity and limits blood pressure problems, back compression, cervical tension and poor circulation.
- **Powerful work:** this easy-to-use electric desk improves your posture, making you more dynamic in your work and therefore productive.
- **Simple and easy adjustment:** thanks to its two motors and its control panel, in a few seconds, you can easily change position by alternating your sitting / standing positions. This desk offers different heights between 62 and 128 cm depending on your morphology.
- **Intelligent:** possibility to program 3 settings (between 62 - 128 cm) and is equipped with a sound reminder (between 1 - 99 min) that will prevent you from changing position during your working day.
- **Scandinavian design:** sober and timeless, the wood-white combination sublimates both large interiors such as reception halls and smaller contemporary spaces.
- **Optimum stability:** the load capacity of the table is 125 Kg, which can accommodate multiple screens, as well as the ergonomic desk organizer ERGO STATION.
- **Complementary products:** recommended to use with footrest UPDOWN multi-position and MOOVE dynamic stool.

- Weight: 52,5 Kg
- Lifting speed: 38 mm per second
- Built-in cable pass under the tray
- Maximum height: 128 cm / minimum height: 62 cm
- Top: 160 cm x 80 cm in beech finish is composed of particle board with high resistance melamine coating (thickness 25 mm).
- Structure and legs: three square sections are made of steel for high resistance and can support up to 125 Kg.

Réf. product	Color	Warranty	Code EAN	EA by box
400124577	White/ beech	2 years	3595560029792	1 pc.



/Air purifiers

1

Ideal to start filtering the ambient air of your individual office

PROBLEMS

Feeling tired, drop in concentration

CAUSES

Unable to renew ambient air at least once a day (windows closed by security)

SOLUTIONS

R'PURE
p 112

2

Perfect to purify look like an open space open space

PROBLEMS

sneezing, nasal discharge, eye irritation

CAUSES

Space temperature high, air charged with fine particles (<2.5PM), germs, molds

SOLUTIONS

R'CLEAN
p 113

3

Thoroughly eliminate harmful gases and odors in the air of a room of 12m²

PROBLEMS

Difficulty breathing without physical effort, irritation and inflammation of the respiratory tract (coughing)

CAUSES

Presence of polluting gases (benzene, radon, ...), allergens and VOCs, presence of odors (sanitary or catering spaces)

SOLUTIONS

AUBE
p 114

/Did you know?

Today:

We spend 90% of our time indoors, and 9 hours each day sharing this space with others. We do not pay much attention to the air we breathe, yet we should. Indoor air is 5 times more polluted than outside air. Public spaces, such as offices, are places where bacteria, viruses, dust, allergens, chemical vapors and odors proliferate. We all know how important it is to wash your hands regularly, or to clean the surfaces that surround us like tables, desks and worktops. But this is not enough. We must also clean our air. And there are good reasons for that.

What is in the air?

Mainly in the air, there are many particles (PM) in suspension. There are different sizes of particles, whether bacteria or allergens but also different harmful gases such as **benzene or carbon dioxide (CO2)** present in the exhaust and can lead to fatigue and lower concentration if its concentration in the air is greater than 1000 ppm ****.

- **coarse particles** with a diameter of between 2.5 microns and 10 microns and which are generally captured by the HEPA filters of the air purifiers that are equipped with them.

- **fine particles** with a diameter of less than 2.5 microns and which are particularly harmful because they penetrate deep within our respiratory system (bronchi and pulmonary alveoli).

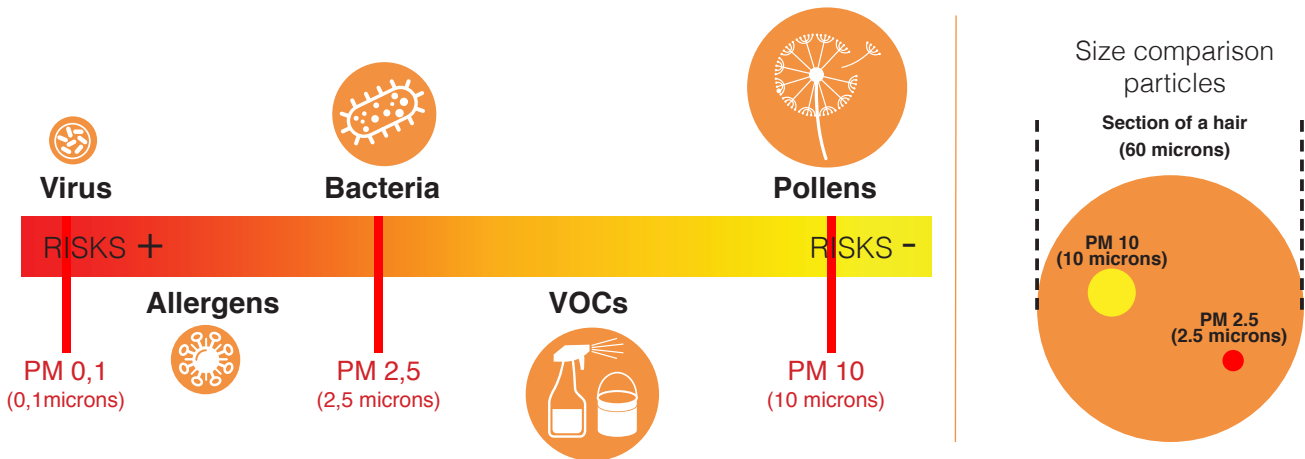

Some figures in France

Public spaces, such as offices, are places where bacteria, viruses, dust, allergens, chemical vapors and odors proliferate. We all know how important it is to wash your hands regularly, or to clean the surfaces that surround us like tables, desks and worktops. But this is not enough. We must also clean our air. And there are good reasons for that.

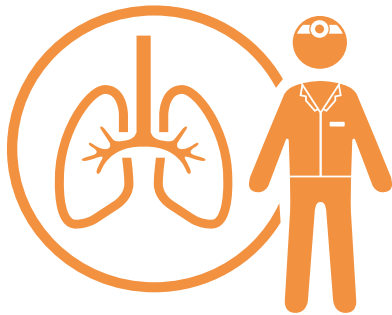

In France, 20 to 25% of the population suffer from respiratory allergy.

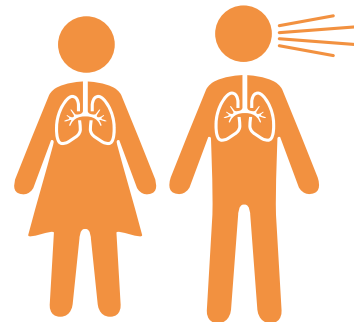

In France, the flu affects between **2 and 8 million** people and is transmitted through the air by coughing, sneezing or talking.

What the law says?

NEW REGULATORY DEVICE 2018-2023 FOLLOWING THE LAW DITE GRENELLE 2 PROMULGATED ON 12 JULY 2010. The National Environmental Commitment Act made the monitoring of indoor air quality mandatory in some institutions that receive sensitive audiences. This obligation will apply in the places and dates below:



January 1, 2018:

Collective reception facilities for children under 6, kindergartens and primary schools.



January 1, 2020:

Recreation centers, educational or vocational training establishments of the second degree: middle school, high schools, ...



January 1, 2023:

ERP: other establishments receiving the public



For more information you can consult the site:
www.developpement-durable.gouv.fr

How much does it cost?

"Between 2014 and 2015 the market doubled from 900,000 to 1.8 million euros", then sales reached 2.8 million euros in 2016, says to AFP Matthieu Cortesse, director of the household appliances segment at GFK. The market is expected to reach \$ 9.6 billion by 2020. Demand continues to rise in the face of declining air quality. Despite this progression, unclean air can be expensive.



€ 45 billion *

This is the direct cost of absenteeism in France linked to influenza or allergy epidemics. Using an air purifier can save 8-11% *.



2 million lost days **

Just for the flu. This figure can rise to 12 million in the event of intense epidemics.



€ 1744 ***

This is the average cost of annual absenteeism per employee in a company.

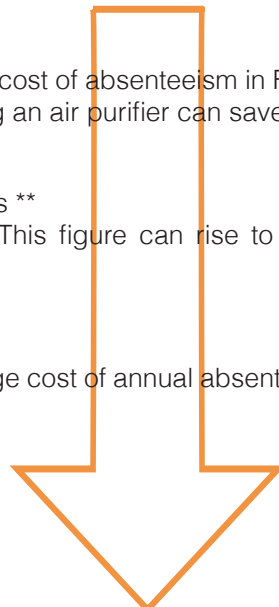

A public health issue for French companies

* and *** Source: <https://roomtech.fr/use-air-purifier-air-why/>

** Source: <https://www.corsematin.com/article/article/what-we-collects-right-the-fluenza-virus->

/Un air sain

The UNILUX solution: our range of air purifiers

Improve the indoor air quality of your office or home with our powerful and efficient air purifiers that safely remove 99.90% of suspended particles from 0.1 to 10 microns in size different filtration systems of our models. Our air purifiers are suitable for both an individual office of about 12m² as an open space of approximately 28m².



R'PURE



R'CLEAN



AUBE

The benefits

* Study conducted by the Green World Building Council: <https://www.airandme.fr/blog/analysis-and-purification-of-lair/quality-of-air-and-productivity-to-work-two-factor-TRES-lies/>

The different filtration systems

A- the air ionizer system:

The air ionizer is a type of air purifier that will generate a large amount of negative ions (anions). These anions will be chemically attracted by the positively charged particles of pollution and this will form amalgam that will gradually increase. With weight, they will either be attracted to the device or fall to the ground if the device is too far away. The air becomes healthy again very quickly. If the ionizer is too close to a wall or furniture, pollution will accumulate and blacken these elements, that is why it is necessary to place the ionizer at a distance from the walls and furniture.

Advantages :

- very fast action and 100% silent
- economical in maintenance and consumption
- effective for capturing small particles below 1 micron

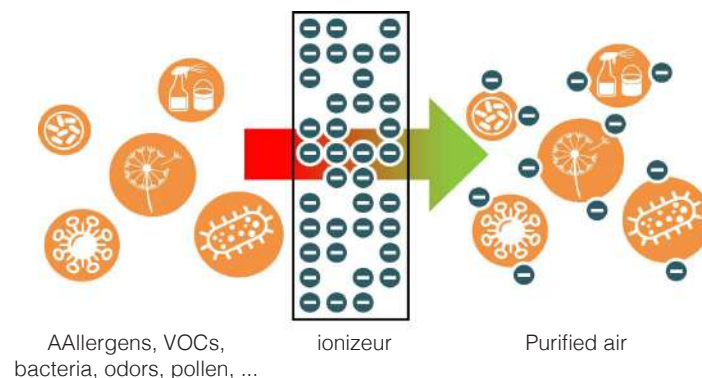

B- the HEPA filtration system:

It is an air purification system that can trap air pollution in the unit thanks to several filters. In general, devices using this method have several layers of filters, the most known being the HEPA filter (High Efficiency Particulate Air filter). This type of filter makes it possible to filter fumes, pollen, bacteria. There are also antistatic filters, activated carbon filters, antibacterial filters, anti-allergenic filters ... to trap all the pollution.

Advantages :

- an air purifier with a sophisticated filtration system that does not let anything pass
- it is the most widespread technique and the most used
- all the pollution is trapped in the filters and not elsewhere

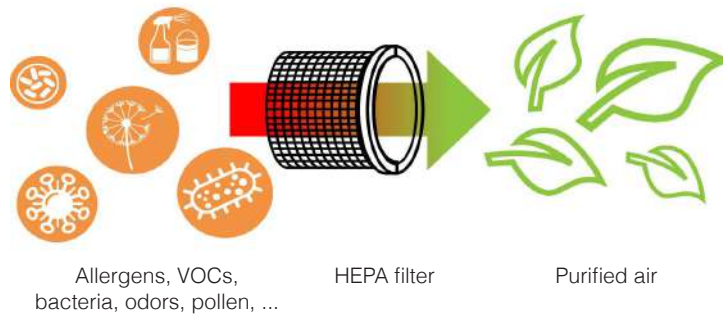

C- the UV filtration system:

The radiation air purifier works with a UV lamp: it is particularly effective against germs, microbes, viruses and bacteria. In short, everything that is alive and that is likely to make you sick. In addition, it oxidizes VOCs and odors.

Advantages :

- very effective against micro-organisms
- the pollution is destroyed

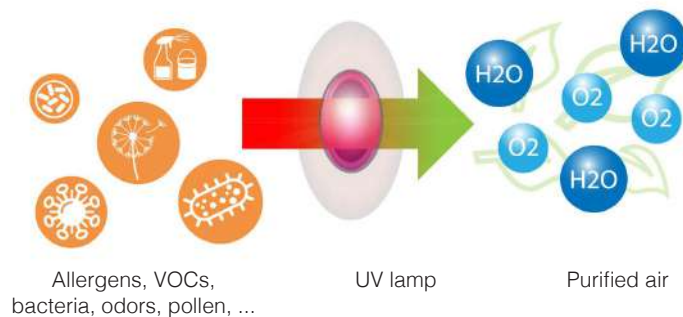

D- the photocatalyst system:

he uses the process of photocatalysis in visible light. It allows to clean the air in depth to purify the interior of your workspace or domicile. Virus, allergens, bacteria, pollutants ... Photocatalysis is very effective in reducing the harmful elements of the air while being totally harmless to human health

Advantages :

- quiet and economical
- does not generate ozone or chemical pollutants

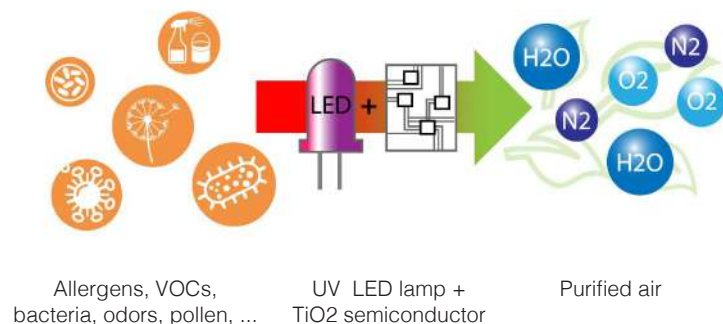



/R'PURE



- **9 hours of our time indoors:** the indoor air is 5 times more polluted than the outside air.
- **Latest generation ionizer system:** Filters up to 99.90% dust, pollen, smoke, odors, mold spores and pet dander and other allergens. Filter ultrafine particles measuring up to 0.3 microns and air pollution PM2.5 (pollution rate) to help improve overall health.
- **Quiet Operation:** Do not worry about noise, this air purifier is incredibly quiet to provide a better comfortable environment. Thanks to its silent fan, you will not be disturbed in your daily tasks at work.
- **Design:** compact and portable for your comfort. Ideally designed for confined spaces or individual spaces smaller than 15m².
- **The product +:** can be used both vertically and horizontally as a screen mount.

- Weight: 0.62 Kg
- Compact and quiet <50 dB
- Perfect for professional or personal use
- Dimensions: 30 cm x 15 cm x 5 cm
- 2 years warranty
- Materials: ABS plastic

Réf. product	Color	Warranty	Code EAN	EA by box
400095490	White/ black	2 years	3595560025817	1 pc.



/R'CLEAN



- **90% of our time indoors:** indoor air is 5 times more polluted than outside air.
- **Smart:** this purifier automatically inform you about the quality of the ambient air thanks to its indicator light (4 levels) indicator of the quality of the air.
- **High Efficiency Filter:** With the latest generation of composite HEPA filter, this indoor air purifier has a high efficiency activated carbon filter, HEPA air purifier can efficiently filter PM2.5.
- **High efficiency and energy saving:** this portable air purifier uses a brushless motor with a power of 4-22 W. This silent air purifier is very energy efficient. This air purifier is suitable for a room of approximately 28 / 30m².
- **Highly efficient ion purification technology:** high efficiency HEPA filter and 99.7% efficient filtration. Fine particles can not pass.
- **Time delay function and UV lamp:** R'CLEAN can be set to switch off, which is more convenient and saves energy. UV lamps use ultraviolet light to sterilize and give you a healthy environment.
- **360° clean design:** thanks to its 360° ventilation, you will obtain an omnidirectional filtration.

- Weight: 1.8Kg
- Compact and quiet (5 speed levels)
- Filter change indicator
- Timer function
- Air treatment capacity: 160 m³ / h
- Dimensions: 34 cm x 22 cm
- Materials: ABS plastic

Réf. product	Color	Warranty	Code EAN	EA by box
400110240	White	2 years	3595560028078	1 pc.



- **Innovation:** the first filter-free air purifier that destroys harmful particles and odors in your workspace.
- **High-performance process:** its advanced technological photocatalysis process uses light and destroys pollutants where a traditional system simply stores them, without generating other harmful elements such as ozone or methanal.
- **“Nomadic” design:** with its neon violet light that emits, this elegant square-shaped product is as practical as it is aesthetic. Discreet, as an object of decoration, it will integrate perfectly in your working environment.
- **Silent:** without filter, this air purifier is discreet, it destroys the harmful molecules without emitting noise (less than 17 dB).
- **Economical:** with a consumption of 4 W and a lifetime of 10 years, it will cost you only 3 to 5 € of electricity per year. Charges on a sector or USB jack (cable supplied).
- **No maintenance:** you will no longer need to change filters or perform spare part replacement work.
- **Quality technological partners:** UNILUX has worked in collaboration with prestigious laboratories in FRANCE such as LNE * and CERTAM ** to develop and test its air purifier.



- Weight: 0.52 Kg
- Compact and quiet <17 dB
- Perfect for professional or personal use
- Dimensions: 10 cm x 10 cm x 10 cm
- Materials: aluminium base / ABS plastic top shell

* LNE, National Laboratory for Metrology and Testing

** CERTAM, center of aerothermal studies and research and engine part of the Carnot ESP

Réf. product	Color	Warranty	Code EAN	EA by box
400124565	White	2 years	3595560029617	1 pc.



Informations techniques

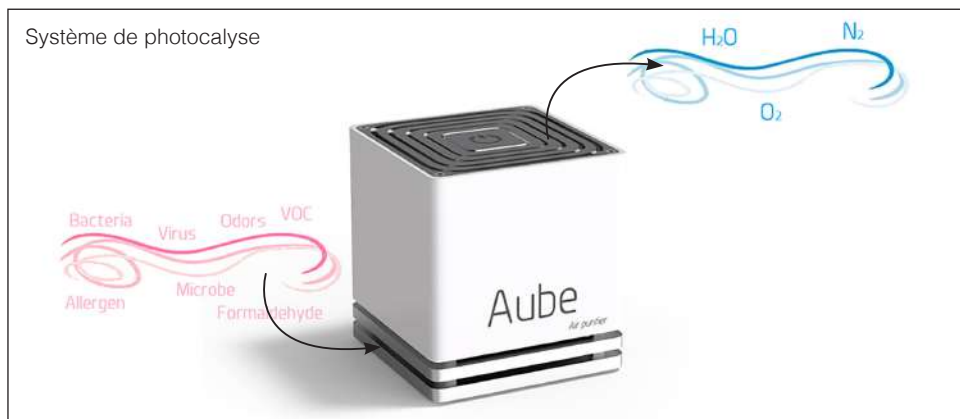
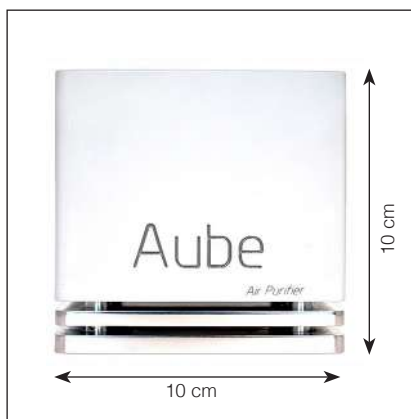





/Clocks

1

Ideal for integrating into everything type of space working

SOLUTIONS

QUARTZ CLOCKS

p 118 to p 121

2

Opt for a professional-looking clock with functionality smart

SOLUTIONS

SILENT CLOCKS

p 122 to p 125

3

Perfect for bring a design touch to your work environment

SOLUTIONS

RADIO-CONTROLLED CLOCKS

p 126 to p 127

p117

Clocks

Features



Silent movement



Radio-controlled



Plug into mains

/ARIA



- **Classic design:** a simple but effective design, this wall clock will fit perfectly to all types of offices.
- **Readability:** With its glass surface of 28 cm and its dual display, this clock will facilitate reading effortlessly up to 30 m.
- **Precision:** Quartz system of high quality allows reliability of a gap of 1 sec in 6 years of operation.

- Operation: powered by a 1.5 V battery power supply (AA) not included
- Dimensions: diameter 28 cm
- Thickness: 3,5cm
- Weight: 0.35 Kg
- Quick wall fixing with 1 eyelet
- 2 years warranty
- Materials: ABS plastic frame / flat mineral glass lid

Réf. product	Color	Consumption	Code EAN	EA by box
400094280	Metal gray	0,07 mA	3595560022366	1 pc.

/MAGNET



- **Practical:** this nomad pendulum adheres to metal surfaces without drilling, thanks to its powerful magnets.
- **Sober design:** with its professional character, this large clock will easily fit into open-space offices.
- **Precision:** Quartz system of high quality allows reliability of a gap of 1 sec in 6 years of operation.

- Operation: powered by a 1.5 V (AA) battery supplied
- Dimensions: diameter 30.5 cm
- Thickness: 4 cm
- Weight: 0.73 Kg
- 2 years warranty
- Possibility also to fix the pendulum to the wall by 1 eyelet
- Materials: ABS plastic frame / flat mineral glass lid



Réf. product	Color	Consumption	Code EAN	EA by box
400094406	Metal gray	0,29 mA	3595560023714	1 pc.

/INSTINCT



- **Intelligent:** a digital display is embedded in the dial and indicates the choice: day / date, date / month or hour / minutes.
- **Accuracy DST SYSTEM:** its mechanism allows it to adjust itself automatically during summer or winter time changes.
- **Contemporary design:** its contemporary design will seduce you with its metallic gray dynamic outline and digital date stamp giving the date of the day. This clock fits all types of offices.

- Operation: powered by a 1.5 V (AA) battery supplied
- Dimensions: diameter 30.5 cm
- Thickness: 4 cm
- Weight: 0.61 Kg
- 2 years warranty
- Possibility also to fix the pendulum to the wall by 1 eyelet
- Materials: ABS plastic frame / flat mineral glass lid

p119

Clocks

Réf. product	Color	Consumption	Code EAN	EA by box
100340853	Metalg ray	0,14 mA	3595560007929	1 pc.

/TEMPUS



- **Intelligent:** the dial is equipped with a precision thermometer, with digital display (indoor temperature of 0° C to + 100° C), to know the temperature of your environment. job.
- **Modern design:** its sober shape and its metallic gray outline allow it to adapt to all the decor from the most classic to the most contemporary.
- **Complementary:** clock perfectly coordinated with LED lamps and UNILUX office accessories (coat rack, footrest, ergonomics products).

- Operation: powered by a 3 x 1.5 V (AA) batteries supplied
- Dimensions: diameter 30.5 cm
- Thickness: 4 cm
- Weight: 0.75 Kg
- 2 years warranty
- Quick wall fixing with 1 eyelet
- Materials: ABS plastic frame / flat mineral glass lid



Réf. product	Color	Consumption	Code EAN	EA by box
400094592	Gris métal	0,21 mA	3595560025282	1 pc.



/MOON



THE + PRODUCT
Backlit display

- **Smart:** this clock has a white backlight system that allows great readability wherever you are in the room.
- **Modern design:** with its contemporary look and beautiful aluminum finish MOON will suit all types of offices.
- **Readability:** a dimension of 31.5 cm for maximum readability up to 35 m thanks to its contrast of large black numbers on a white background.
- **Precision:** Quartz system of high quality allows reliability of a gap of 1 sec in 6 years of operation.
- **Robustness:** thanks to its aluminum frame, this clock with beautiful finishes withstands any test.

- Operation: mains connection (cable supplied).
- Thickness: 4.5 cm
- Dimensions: diameter: 30.5 cm
- Weight: 1.05 Kg
- Quick wall fixing with 1 eyelet
- Materials: aluminum frame / flat mineral glass lid

Réf. product	Color	Consumption	Code EAN	EA by box
400094569	Metal gray	0,22 mA	3595560025220	1 pc.

/ON TIME



- **The + product:** four time zones are available to be responsive all over the world (France, London, Tokyo and New York).
- **Contemporary design:** its white numbers on a black background and its finishes, give it a very contemporary and elegant look. Perfect for open space and halls.
- **Precision:** Quartz system of high quality allows reliability of a gap of 1 sec in 6 years of operation.

- Operation: powered by 4 x 1.5 V (AA) batteries supplied
- Dimensions: diameter 30.5 cm
- Thickness: 4 cm
- Weight: 0.80 Kg
- 2 years warranty
- Quick wall fixing with 1 eyelet
- Materials: ABS plastic frame / flat mineral glass lid

p121

Clocks

Réf. produit	Couleur	Consommation	Code EAN	Qté/carton
400094567	Nior	0,21 mA	3595560025114	1 pc.

/MEGA



- **Practical:** a dimension of 57.5 cm for a maximum readability up to 180m. This large clock is particularly suitable for large areas (open-spaces, warehouses, meeting rooms, dining rooms, ..).
- **Modern design:** its contemporary look and its white numbers on a black background allows a visual contrast conducive to reading.
- **Complementary:** clock perfectly coordinated with LED lamps and UNILUX office accessories (coat rack, footrest, ergonomics products).

- Operation: powered by a 1.5 V (AA) battery supplied
- Dimensions: diameter 57.5 cm
- Thickness: 7 cm
- Weight: 3.45 Kg
- 2 years warranty
- Quick wall fixing with 1 eyelet
- Materials: ABS plastic frame / flat mineral glass lid

Réf. product	Color	Consumption	Code EAN	EA by box
400094568	Black	0,21 mA	3595560025183	1 pc.

/POP

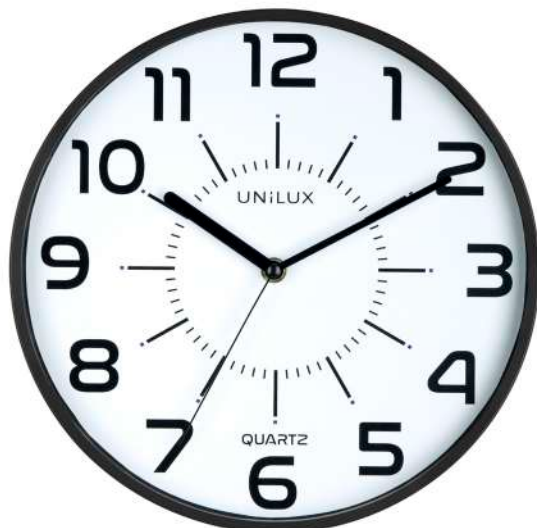

- **Ergonomics:** thanks to its quiet system, the second hand emits no noise creating a framework conducive to concentration for work.
- **Pop design:** available in 6 colors, this functional and decorative clock will bring the touch of color in your office.
- **Readability:** a 28 cm dimension for maximum readability up to 30 m thanks to its contrast of large black numbers on a white background and its fine frame.
- **Complementary:** clock perfectly coordinated with LED lamps and UNILUX office accessories (coat rack, footrest, ergonomics products).

- Operation: powered by a 1.5 V (AA) battery supplied
- Dimensions: diameter 28 cm
- Thickness: 3,5cm
- Weight: 0.46 Kg
- 2 years warranty
- Quick wall fixing with 1 eyelet
- Materials: ABS plastic frame / flat mineral glass lid

Réf. product	Color	Consumption	Code EAN	EA by box
400094281	Black	0,20 mA	3595560022496	1 pc.
400094282	White	0,20 mA	3595560022618	1 pc.
400094283	Metal gray	0,20 mA	3595560022656	1 pc.
400094560	Blue	0,20 mA	3595560024070	1 pc.
400094284	Green	0,20 mA	3595560022663	1 pc.
400094285	Purple	0,20 mA	3595560022854	1 pc.

/MAXI POP

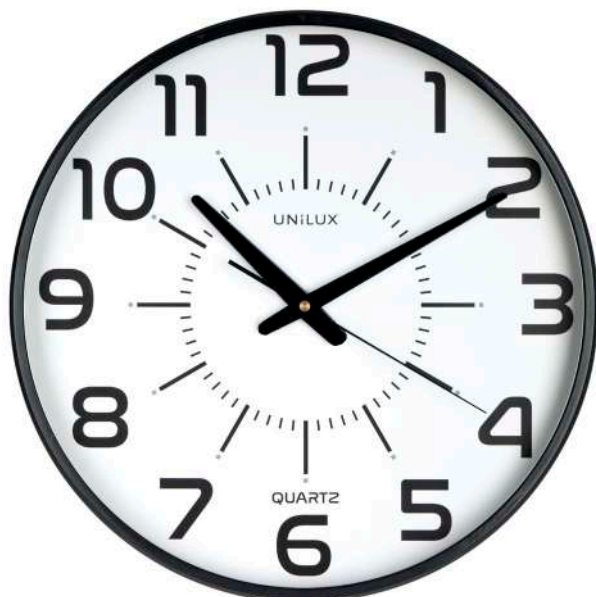

- **Ergonomics:** thanks to its quiet system, the second hand emits no noise creating a framework conducive to concentration for work.
- **Modern design:** this large functional and decorative clock will harmonize perfectly in open-space offices.
- **Readability:** a 37.5 cm dimension for maximum readability up to 150 m thanks to its contrast of large black numbers on a white background.
- **Precision:** Quartz system of high quality allows reliability of a gap of 1 sec in 6 years of operation.
- **Complementary:** clock perfectly coordinated with LED lamps and UNILUX office accessories (coat rack, footrest, ergonomics products).

- Operation: powered by a 1.5 V (AA) battery supplied
- Dimensions: diameter 37.5 cm
- Thickness: 5 cm
- Weight: 1.18 Kg
- Quick wall fixing with 1 eyelet
- 2 years warranty
- Materials: ABS plastic frame / flat mineral glass lid

Réf. product	Color	Consumption	Code EAN	EA by box
400094487	Black	0,22 mA	3595560023905	1 pc.
400094488	Metal gray	0,22 mA	3595560023936	1 pc.





/BALTIC



- **Scandinavian design:** sober and timeless, the wood-white combination sublimates both large interiors such as reception halls and smaller contemporary spaces.
- **Readability:** a dimension of 31.5 cm for maximum readability up to 35 m thanks to its contrast of large black numbers on a white background.
- **Ergonomics:** thanks to its quiet system, the second hand emits no noise creating a framework conducive to concentration for work.
- **Precision:** Quartz system of high quality allows reliability of a gap of 1 sec in 6 years of operation.
- **Complementary products:** clock perfectly coordinated with the VICKY LED lamp, PRYSKA floor lamp, ACCESS coat rack and the ERGO WELL electrical desk.

- Operation: Powered by a 1.5 V (AA) battery supplied
- Thickness: 3.5 cm
- Dimensions: diameter: 31.5 cm
- Weight: 0.77 Kg
- Quick wall fixing with 1 eyelet
- Materials: beech wood frame * / flat mineral glass lid

* The wood used in this product comes from a forest managed in an eco-responsible way

Réf. product	Color	Consumption	Code EAN	EA by box
400094591	White/ beech	0,21 mA	3595560025251	1 pc.

/ATTRACTION



THE + PRODUCT
Magnetic fixing

- **Ergonomics:** thanks to its quiet system, the second hand emits no noise creating a framework conducive to concentration for work.
- **Practical:** this nomad pendulum adheres to metal surfaces without drilling, thanks to its powerful magnets.
- **Sober design:** with its professional character, this clock will easily fit into your office.
- **Precision:** Quartz system of high quality allows reliability of a gap of 1 sec in 6 years of operation.

- Operation: powered by a 1.5 V (AA) battery supplied
- Dimensions: diameter 22 cm
- Thickness: 4 cm
- Weight: 0.41 Kg
- 2 years warranty
- Possibility also to fix the pendulum to the wall by 1 eyelet
- Materials: ABS plastic frame / flat mineral glass lid

p125

Clocks

Réf. produit	Color	Consumption	Code EAN	EA by box
400094404	Metal gray	0,28 mA	3595560023318	1 pc.

/FLO LED



- **Quiet:** compared to conventional clocks, this electric clock does not emit any noise harmful to concentration and productivity.
- **High tech and modern design:** its black square dial with aluminum contour provides information with blue LEDs that gives it a trend and contemporary look compatible with all styles of workspace (lobby, meeting and office).
- **Have everything in view:** Display days of the week, date and indoor temperature from -9° C to + 50° C.
- **Readable day and night:** thanks to a dimension of 28 cm and its contrast of large digital digits LED blue of 6 cm height on a black background.
- **Smart:** no need to change the battery, this LED pendulum connects directly to mains (cable = 1m 80)

- Operation: mains connection (cable supplied).
- Intuitive operation: silent keys
- Dimensions: 28 cm x 28 cm
- Thickness: 3.5 cm
- Weight: 0.83 Kg
- Quick wall fixing with 2 eyelets
- Materials: aluminum frame / flat mineral glass lid

Réf. produit	Color	Consumption	Code EAN	Qté/carton
400124566	Black/ metal gray	0,28 mA	3595560029648	1 pc.

/WAVE



- **Radio controlled:** the time is permanently adjusted permanently by radio waves from the Atomic Clock in Mainflingen. High accuracy: 1 second maximum difference in 1 million years.
- **Sober design:** a simple but effective design, this wall clock will fit perfectly to all types of offices.
- **Readability:** a dimension of 30 cm for maximum legibility up to 35 m thanks to its contrast of large black numbers on a white background and its fine frame.
- **Complementary:** clock perfectly coordinated with LED lamps and UNILUX office accessories (coat rack, footrest, ergonomics products).

- Operation: powered by a 1.5 V (AA) battery supplied
- Dimensions: diameter 30 cm
- Thickness: 4.5 cm
- Weight: 0.59 Kg
- Quick wall fixing with 1 eyelet
- 2 years warranty
- Materials: ABS plastic frame / flat mineral glass lid



USE RESTRICTIONS:

- does not work in buildings with metal structure
- does not work near a high frequency transmitter (eg PC)
- does not operate at a distance of more than 1500 km from the signal transmitter (Mainflingen in Germany) and depends on topographic conditions

Réf. product	Color	Consumption	Code EAN	EA by box
400094561	Black	0,37 mA	3595560024186	1 pc.
400094563	White	0,37 mA	3595560024711	1 pc.
400094562	Metal gray	0,37 mA	3595560024445	1 pc.

/MAXI WAVE



- **Radio-controlled:** The time is permanently adjusted by radio waves from the Atomic Clock in Mainflingen. High accuracy: 1 second maximum difference in 1 million years.
- **Sober design:** a simple but effective design, this wall clock will fit perfectly to all types of offices.
- **Readability:** a 37.5 cm dimension for maximum readability up to 150 m thanks to its contrast of large black numbers on a white background.
- **Complementary:** clock perfectly coordinated with LED lamps and UNILUX office accessories (coat rack, footrest, ergonomics products).

- Operation: powered by a 1.5 V (AA) battery supplied
- Dimensions: diameter 37.5 cm
- Thickness: 4.5 cm
- Weight: 1.20 Kg
- Quick wall fixing with 1 eyelet
- 2 years warranty
- Materials: ABS plastic frame / flat mineral glass lid



USE RESTRICTIONS:

- does not work in buildings with metal structure
- does not work near a high frequency transmitter (eg PC)
- does not operate at a distance of more than 1500 km from the signal transmitter (Mainflingen in Germany) and depends on topographic conditions

Réf. product	Color	Consumption	Code EAN	EA bybox
400094564	Black	0,22 mA	3595560024919	1 pc.
400094565	Metal gray	0,22 mA	3595560024940	1 pc.

/STATION



- **Radio-controlled:** The time is permanently adjusted by radio waves from the Atomic Clock in Mainflingen. High accuracy: 1 second maximum difference in 1 million years.
- **Ergonomics:** thanks to its quiet system, the second hand emits no noise creating a framework conducive to concentration for work.
- **Timeless design:** its "station clock" look with its black rectangular hands and scarlet red second hand will energize your office. It will be perfect for all types of offices.
- **Readability:** a 35 cm dimension for maximum readability up to 35 m thanks to its black contrast on a white background.
- **Robustness:** thanks to its steel frame, this clock with beautiful finishes withstands any test.

- Operation: Powered by a 1.5 V (AA) battery supplied
- Dimensions: diameter 35 cm
- Thickness: 4.5 cm
- Weight: 0.95 Kg
- Quick wall fixing with 1 eyelet
- 2 years warranty
- Materials: steel frame / flat mineral glass lid



USE RESTRICTIONS:

- does not work in buildings with metal structure
- does not work near a high frequency transmitter (eg PC)
- does not operate at a distance of more than 1500 km from the signal transmitter (Mainflingen in Germany) and depends on topographic conditions

Réf. product	Color	Consumption	Code EAN	EA by box
400124567	Metal gray	0,29 mA	3595560029679	1 pc.

p127

Clocks

/OUTDOOR



- **Waterproof:** thanks to its sealing system (IP 41), this quality metal frame clock is suitable for both indoors and outdoors.
- **Radio-controlled:** The time is permanently adjusted by radio waves from the Atomic Clock in Mainflingen. High accuracy: 1 second maximum difference in 1 million years.
- **Ergonomics:** thanks to its quiet system, the second hand emits no noise creating a framework conducive to concentration for work.
- **Robustness:** thanks to its stainless steel frame, this clock with beautiful finishes withstands any test.

- Operation: powered by a 1.5 V (AA) battery supplied
- Dimensions: diameter 35.5 cm
- Thickness: 4.5 cm
- Weight: 1.08 Kg
- Quick wall fixing with 1 eyelet
- 2 years warranty
- Materials: stainless steel frame / flat mineral glass lid



USE RESTRICTIONS:

- does not work in buildings with metal structure
- does not work near a high frequency transmitter (eg PC)
- does not operate at a distance of more than 1500 km from the signal transmitter (Mainflingen in Germany) and depends on topographic conditions

Réf. product	Color	Consumption	Code EAN	EA by box
400094566	Metal gray	0,22 mA	3595560025053	1 pc.



/Reception

1

Ideal for
integrating into an
individual office or
community

•
SOLUTIONS

COAT
PEGS

p 130 to p 133

2

Also suitable
good for an office than
for an open space or a
meeting room

•
SOLUTIONS

COAT
STANDS

p134 to p 141

3

Perfect for large
living areas such as
lobbies and reception
areas

•
SOLUTIONS

GARMENT
RACKS

p 142 to p 143

p129

Reception

/FIL



- **Functional:** the double hook, rounded shape can juxtapose clothing while ensuring their perfect maintenance and respect.
- **Robust:** supports up to 50 kg of load while respecting the clothes.
- **Bestseller:** a must-have model that will fit perfectly any office.
- **Fixation:** delivered with its mounting kit containing screws and plugs for easy attachment to surfaces of all types.
- **Available in 3 sizes:** single, double and triple.
- **Available in four colors:** black (x1, x2, x3) or blue (x2, x3 until the end of 2020) or green (x3 until the end of 2020)

- Dimensions 1 hook: 14.6 cm x 8 cm
- Dimensions 2 hook: 14.6 cm x 23 cm
- Dimensions 3 hook: 14.6 cm x 37.5 cm
- 2 years warranty
- Materials: ABS plastic and glossy Cicolac

Réf. produit	Color	Height	Code EAN	EA by box
100340652	Black (x1)	14,6 cm	3595560001293	1 pc.
100340662	Black (x2)	14,6 cm	3595560001385	1 pc.
400095398	Blue (x2)	14,6 cm	3595560025510	1 pc.
100340674	Black (x3)	14,6 cm	3595560001460	1 pc.
400095451	Green (x3)	14,6 cm	3595560025602	1 pc.
400095450	Blue (x3)	14,6 cm	3595560025572	1 pc.

/FIL MAGNETIC



- **Fixing:** Thanks to its powerful ferro-nickel magnet, the hook is easily attached to any metal support (wall, cabinet). No drilling operation.
- **Functional:** this rounded coat hook ensures the perfect fit of clothing and ensures respect.
- **Resistance:** supports up to 12 kg of load while respecting the clothes.
- **Fixing:** Thanks to its powerful ferro-nickel magnet, the hook is easily attached to any metal support (wall, cabinet). No drilling operation.
- **Available in four colors:** black or gray or blue or green.

- Dimensions: 10 cm x 8 cm
- 2 years warranty
- Materials: ABS plastic and glossy Cicolac



Réf. product	Color	Height	Code EAN	EA by box
100340762	Black	10 cm	3595560004430	1 pc.
100340769	Gray	10 cm	3595560009671	1 pc.
400095455	Green	10 cm	3595560025701	1 pc.
400095454	Blue	10 cm	3595560025671	1 pc.

/FIL MULTIPLE



- **Functional:** these multiple hooks, rounded shape, can juxtapose clothing while ensuring their perfect maintenance and respect.
- **Robust:** supports up to 50 kg of load while respecting the clothes.
- **Bestseller:** a must-have model that will fit perfectly any office.
- **Fixation:** delivered with its mounting kit containing screws and plugs for easy attachment to surfaces of all types.
- **Anti-theft system:** has a cap screw cap guaranteeing total inviolability.
- **Available in four colors:** black, blue or green.

- Dimensions: 14.6 cm x 2x45 cm
- 2 years warranty
- Materials: ABS plastic and glossy Cicolac



Réf. product	Color	Height	Code EAN	EA by box
100340685	Black	14,6 cm	3595560001521	1 pc.
400095453	Green	14,6 cm	3595560025657	1 pc.
400095452	Blue	14,6 cm	3595560025633	1 pc.

p131

Coat pegs

/HAKEA

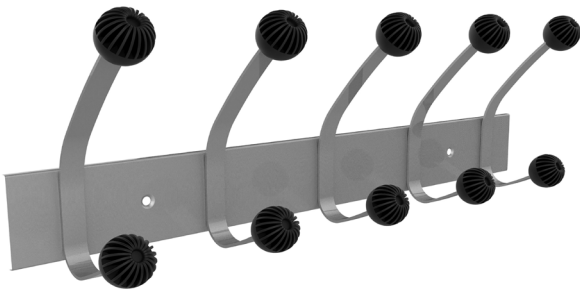

- **Contemporary design:** its dynamic look, beautiful gray metal finishes make these coat hooks the ideal accessory for your office.
- **Functional:** double hooks available in three different sizes x2, x3, x5.
- **Use:** individual or collective use.
- **Fixation:** supplied with mounting kit containing screws and plugs for easy attachment to all surfaces.

- Supports up to 40 Kg
- Dimensions 2 hooks: 21 cm x 29 cm
- Dimensions 3 hooks: 21 cm x 34.5 cm
- Dimensions 5 hooks: 21 cm x 57.5 cm
- 2 years warranty
- Materials: high quality steel with epoxy paint and ABS plastic

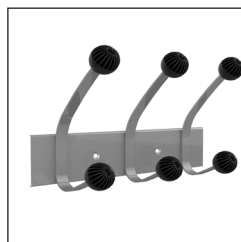
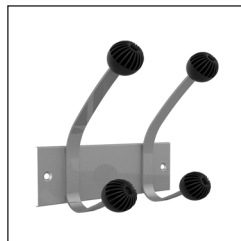

Réf. product	Color	Height	Code EAN	EA by box
400095645	Metal gray(x2)	21 cm	3595560026241	1 pc.
400095646	Metal gray(x3)	21 cm	3595560026258	1 pc.
400095647	Metal gray(x5)	21 cm	3595560026265	1 pc.

/STEELY

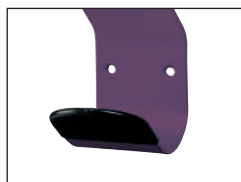

- **Functional:** the double hook, with its rounded non-slip plastic end caps allow to juxtapose clothing while ensuring their perfect maintenance and respect.
- **Modern design:** trendy and colorful, this hook with soft and subtle lines made of steel will bring color and energize your workspace.
- **Robust:** supports up to 50 kg of load while respecting the clothes.
- **Fixation:** delivered with its mounting kit containing screws and plugs for easy attachment to surfaces of all types.
- **Available in five colors:** black, metallic gray, white, purple or green.

- Thick steel sheet: 4 mm
- Dimensions: 6.8 cm x 14.8 cm x 7.6 cm
- 2 years warranty
- Materials: high quality steel with Epoxy paint and PVC tip



Réf. product	Color	Height	Code EAN	EA by box
100340731	Black	14,8 cm	3595560004850	1 pc.
100340732	Metal gray	14,8 cm	3595560004867	1 pc.
400064681	White	14,8 cm	3595560011636	1 pc.
400064680	Green	14,8 cm	3595560011629	1 pc.
400064682	Purple	14,8 cm	3595560011643	1 pc.

/STEELY MAGNETIC



- **Fixing:** Thanks to its powerful ferro-nickel magnet, the hook is easy to fix on any metal support (metal upright, cabinet). No drilling operation.
- **Modern design:** trendy and colorful, this soft and subtle hook made of steel will bring color and dynamise your workspace.
- **Functional:** its round tip made of non-slip plastic does not deform clothes.
- **Robust:** supports up to 12 kg of load while respecting the clothes.
- **Available in five colors:** black or gray metal or white or purple or green.

- Thick steel sheet: 4 mm
- Dimensions: 6.8 cm x 14.8 cm x 7.6 cm
- 2 years warranty
- Materials: high quality steel with Epoxy paint and PVC tip



Réf. product	Color	Height	Code EAN	EA by box
100340733	Black	14,8 cm	3595560004874	1 pc.
100340734	Metal gray	14,8 cm	3595560004881	1 pc.
400064647	White	14,8 cm	3595560011605	1 pc.
400064646	Green	14,8 cm	3595560011599	1 pc.
400064648	Purple	14,8 cm	3595560011612	1 pc.



/CYPRES



- **Functional:** this triple hanging hook perfectly respects the clothes that it supports.
- **Modern design:** Made of recyclable aluminum and high quality steel, this coat hook will fit all work spaces.
- **Robust:** supports up to 50kg of load by not deforming clothes.
- **Fixation:** delivered with its mounting kit containing screws and plugs for easy attachment to surfaces of all types.

- Supports up to 50 Kg
- Dimensions 2 hooks: 15 cm x 20 cm x 9 cm
- Dimensions 4 hooks: 15 cm x 40 cm x 9 cm
- 2 years warranty
- Materials: high quality steel with epoxy and aluminum paint



Réf. product	Color	Height	Code EAN	EA by box
100340804	Black/ metal gray	15 cm	3595560009589	1 pc.
100340805	Black/ metal gray	15 cm	3595560009879	1 pc.

/ACCESS

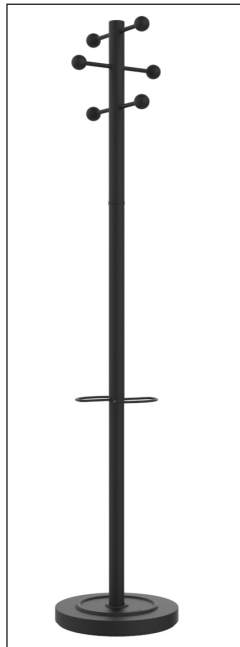

- **Modern and practical design:** Made of recyclable aluminum and high-quality steel, this simple and modern coat rack will fit all work spaces.
- **Functional:** equipped with 6 offset hooks, this coat rack will ensure the perfect maintenance and respect of your clothes.
- **Clever:** Equipped with an umbrella stand that holds up to 6 umbrellas at a time and a drip tray.
- **Ideal in areas of passage:** weighted base ensuring good stability of the coat rack.
- **Convenient:** easy and fast installation (in 4mins) without tools.
- **Complementary products:** coat stand perfectly coordinated with the VICKY LED lamp, PRYSKA floor lamp, ACCESS coat rack and the ERGO WELL electrical desk.

- Tube: diameter 3.5 cm
- 6 plastic hooks ABS
- Weighted base: 5.4 Kg, diameter 34 cm
- Umbrella stand: capacity 6 umbrellas
- Available in two colors: white / beech or black
- Materials: steel mast with Epoxy paint and wood * beech finish / plastic ABS pegs / steel umbrella stand with Epoxy paint
- 2 years warranty
- Recyclability: disassemble and reintegrate into the material use circuit

* Wood from managed eco-friendly forests

Réf. product	Color	Height	Code EAN	EA by box
400095392	White/ beech	175 cm	3595560025411	1 pc.
400095391	Black	175 cm	3595560025398	1 pc.

/TIPY



- **Original design:** tippy-shaped, this minimalist and modern look is ideal for individual offices in contemporary or Scandinavian style.
- **Robust and stable:** Made of bamboo, its vertical design and quadripod base provide excellent stability. We recommend that you hang your clothes evenly distributed.
- **Decorative function:** with or without load, this artistic structure will be a decorative element bringing charm and elegance to your office.
- **Convenient:** easy and fast editing (4 mins).

- 4 poles: rectangular section 2 cm x 3.5 cm
- 4 hooks that do not deform clothes
- Stand: 4 stable feet
- 2 years warranty
- Materials: bamboo

Réf. product	Color	Height	Code EAN	EA by box
400124575	Bamboo	175 cm	3595560029730	1 pc.

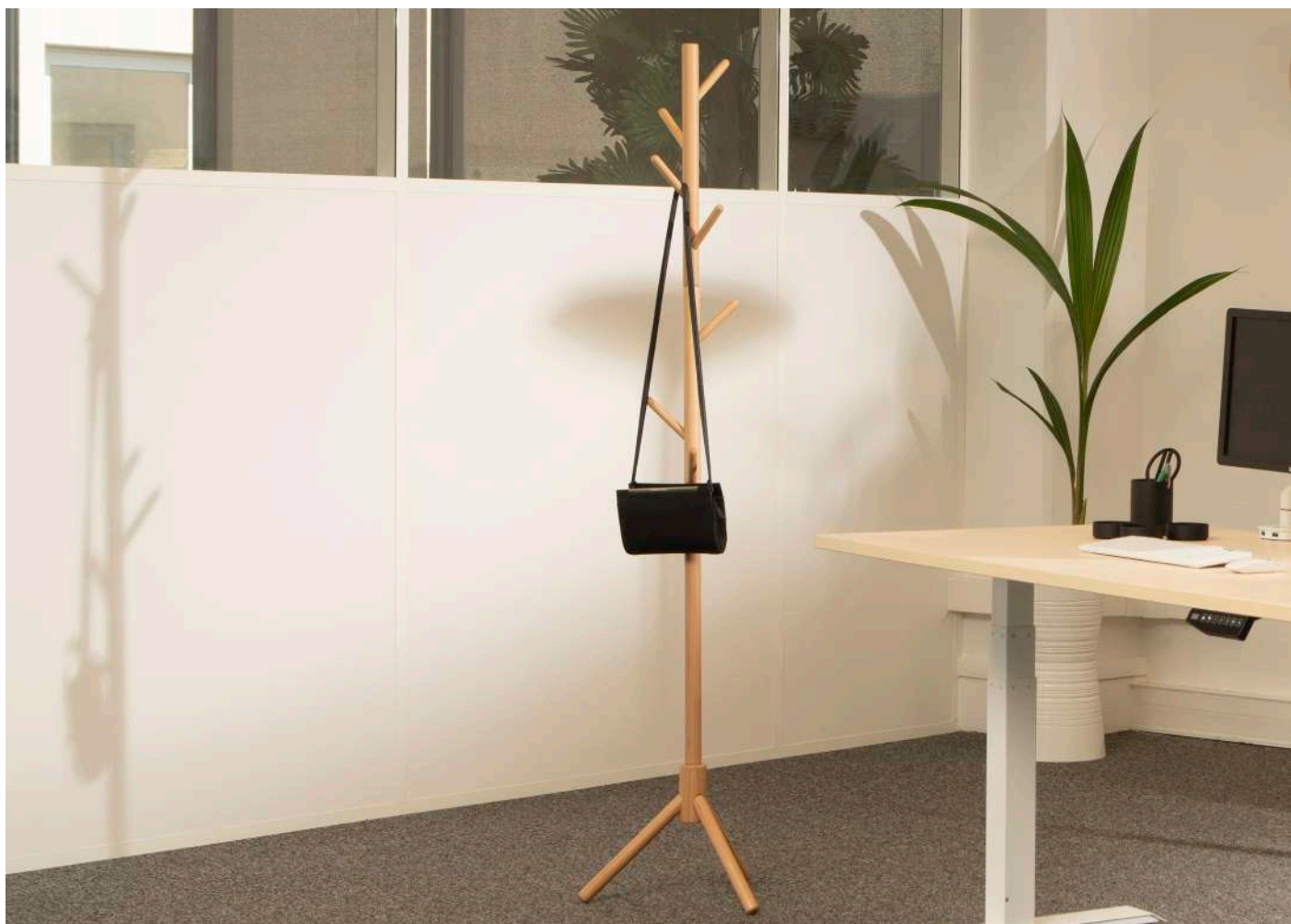

/MIKADO

p135

Coat stands

- **Original design:** this coat stand in beech wood with rounded hooks is an essential accessory, with a trendy original design that will fit easily into any office space (individual or collective).
- **Functional:** 8 rounded hooks arranged in staggered quilts designed to prevent clothes from becoming deformed.
- **Robustness and maneuverability:** Robust design, this coat stand is ideal for storing jackets, coats and various accessories (bags, hats, scarf) and is easily transported from one workspace to another.
- **Stability:** its base tripod-shaped ensures good stability.
- **Simple assembly:** easy and fast assembly (4 mins) without tools.
- **Complementary products:** coat stand perfectly coordinated with the VICKY LED lamp, PRYSKA floor lamp, ACCESS coat rack and the ERGO WELL electric desk.

- Tube: diameter 3 cm
- 8 hooks in staggered beech wood finish
- Base: wooden tripod * beech finish
- 2 years warranty
- Materials: entirely in wood * beech

* Wood from managed eco-friendly forests



Réf. product	Color	Height	Code EAN	EA by box
400124574	Beech	177 cm	3595560029709	1 pc.

/BOUQUET

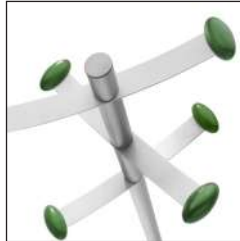

- **Classic design:** simple and effective this slender and sturdy coat stand, made of high quality steel will integrate with all types of offices.
- **Functional:** equipped with 6 hooks fixed offset and its high quality steel shaft.
- **Clever:** equipped with a steel umbrella stand with drainer.
- **Ideal in areas of passage:** weighted base ensuring good stability of the coat stand.
- **Practical:** easy and fast assembly (4 mins) without tools.

- Tube: diameter 3.5 cm
- 6 real wooden coat hooks
- Weighted base: 5.4 Kg, diameter 34 cm
- Umbrella stand: capacity 6 umbrellas
- Available in 3 colors: gray metal / beech, gray metal / vvert, gray metal / burgundy
- Materials: steel mast with epoxy paint / steel and wooden coat hooks * genuine / steel umbrella stand with epoxy paint
- 2 years warranty
- Recyclability: disassemble and reintegrate into the material use circuit

* Wood from managed eco-friendly forests

Réf. product	Color	Height	Code EAN	EA by box
400069048	Metal gray/ beech	173 cm	3595560011933	1 pc.
400079775	Metal gray/ green	173 cm	3595560013005	1 pc.
400079772	Metal gray/ burgundy	173 cm	3595560012992	1 pc.

/ELANCIAL

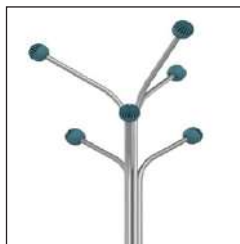
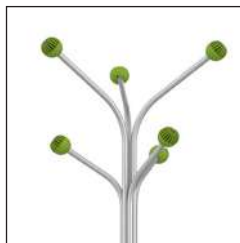
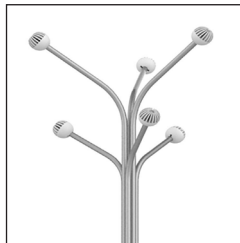

- **Sparkling design:** its slender, modern shape with rounded coat hooks will bring dynamism to your workspace.
- **Functional:** its 6 hooks in the form of half-spherical slats in offset allow a great capacity of attachment and guarantee the respect of the clothes.
- **Clever:** equipped with an umbrella stand and a drip tray.
- **Weighted pedestal of 5,4kg:** with protective pads ensures the stability of the coat stand, whatever the load.
- **Convenient:** easy and fast installation (in 4mins) without tools.
- **Complementary:** coat stand perfectly coordinated with LED lamps and UNILUX office accessories (pendulums, footrests, ergonomics products).

- Tube: diameter 3.5 cm
- 6 plastic hooks ABS
- Weighted base: 5.4 Kg, diameter 34 cm
- Umbrella stand: capacity 6 umbrellas
- Available in four colors: black / gray or white / gray or green / gray or blue / gray
- Materials: steel mast with Epoxy paint / plastic coat hooks ABS / steel umbrella stand with epoxy paint
- 2 years warranty
- Recyclability: disassemble and reintegrate into the material use circuit

Réf. product	Color	Height	Code EAN	EA by box
400106609	Gray/ black	180 cm	3595560002900	1 pc.
400106744	Gray/ white	180 cm	3595560027637	1 pc.
400106746	Gray/ green	180 cm	3595560027651	1 pc.
400106745	Gray/ blue	180 cm	3595560027644	1 pc.



p137

Coat stands

/ACCUEIL

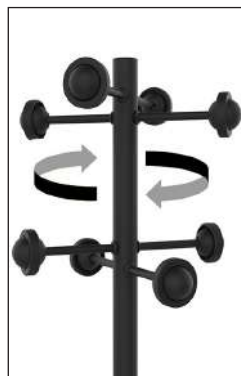

- **Classic design:** Available in 11 colors, this timeless coat stand with rounded coat hooks will bring a touch of color to your workspace.
- **Functional:** this revolving coat rack has 8 round hooks with anti-slip edges that do not deform clothing. The staggered arrangement prevents the coats from overlapping.
- **Clever:** equipped with an umbrella stand that holds up to 9 umbrellas simultaneously.
- **Weighted pedestal of 5.4 kg:** ensures the stability of the coat rack, whatever the load.
- **Convenient:** Easy and fast assembly (4mins) without tools.

- Tube: diameter 3.5 cm
- 8 ABS plastic hooks
- Weighted base: 5.4 Kg, diameter 34 cm
- Umbrella stand: capacity 9 umbrellas
- Available in two colors: white / beech or black
- Materials: steel mast with Epoxy paint / ABS plastic hangers / Polypropylene umbrella stand
- Garnatie: 2 years
- Recyclability: disassemble and reintegrate into the material use circuit

Réf. product	Color	Height	Code EAN	EA by box
100340694	Black	175 cm	3595560008827	1 pc.
100340698	Metal gray	175 cm	3595560008872	1 pc.
100340696	White	175 cm	3595560008858	1 pc.
400017761	Green	175 cm	3595560002627	1 pc.
400095219	Purple	175 cm	3595560024803	1 pc.
400095390	Blue	175 cm	3595560025374	1 pc.
100340697	Chrome	175 cm	3595560008865	1 pc.
100340704	Metal gray/ beech	175 cm	3595560009237	1 pc.
100340703	Metal gray/ cherrish	175 cm	3595560009220	1 pc.
100340701	Black/ beech	175 cm	3595560009251	1 pc.
100340700	Black/ cherrish	175 cm	3595560009244	1 pc.

/FLORA x6



- **Modern design:** thanks to its curved and soft shape, the hooks of this coat stand give it a contemporary look that will harmonize perfectly with all types of workspaces.
- **Functional:** this coat rack, with rotating head has 3 to 6 robust hooks, ensuring the perfect maintenance of clothing.
- **Clever:** equipped with a steel umbrella stand with drainer.
- **Convenient:** easy assembly (in 4mins) and fast

- Tube: diameter 3.5 cm
- 3 or 6 Plastic Polypropylene Hooks + 12 Hooks
- Weighted base: 5.4 Kg, diameter 34 cm
- Umbrella stand: capacity 9 umbrellas
- Rotating head
- Available in two colors: black / mast black or black / mast gray metal
- Materials: steel drum with Epoxy paint / plastic hangers Polypropylene / Polypropylene umbrella stand
- 2 years warranty
- Recyclability: disassemble and reintegrate into the material use circuit

Réf. product	Color	Height	Code EAN	EA by box
100340711	Black(x6)	175 cm	3595560015757	1 pc.
100340712	Black/ Metal gray(x6)	175 cm	3595560015825	1 pc.
100340710	Black(x3)	165 cm	3595560015740	1 pc.

/HAKEA



- **Contemporary design:** its dynamic look, beautiful chrome finishes make this coat rack the perfect accessory for your office.
- **Functional:** this revolving coat rack has 12 hooks in the shape of half-spherical slats ensures the perfect maintenance of coats.
- **Ideal in areas of passage:** base weighted 5.4Kg ensuring good stability of the coat rack.
- **Complementary:** coat stand perfectly coordinated with LED lamps and UNILUX office accessories (pendulums, footrests, ergonomics products).
- **Practical:** easy and fast assembly (4 mins) without tools.

- Tube: diameter 3.5 cm
- 12 steel hooks and ABS plastic
- Weighted base: 5.4 Kg, diameter 34 cm
- Rotating head
- Umbrella holder: capacity 6 umbrellas
- Materials: steel barrel with epoxy paint / coat hooks and ABS plastic / steel umbrella stand with Epoxy paint
- 2 years warranty
- Recyclability: disassemble and reintegrate into the material use circuit

Réf. product	Color	Height	Code EAN	EA by box
400095393	Black/ chrome	176 cm	3595560025435	1 pc.



/CYPRES

p139

Coat stands

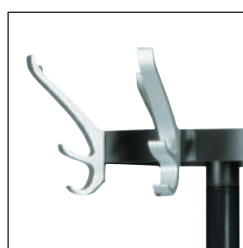

- **Modern and practical design:** Made of recyclable aluminum and high-quality steel, this simple and modern coat rack will fit all work spaces.
- **Functional:** with its rotating head, this coat rack equipped with 8 triple hooks has a capacity of 24 clothes.
- **Clever:** Equipped with an umbrella stand that holds up to 6 umbrellas at a time and a drip tray.
- **Ideal in areas of passage:** weighted base ensuring good stability of the coat stand.
- **Convenient:** easy assembly (in 4mins) and fast

- Tube: diameter 3.5 cm
- 8 triple hooks in aluminum recycle
- Crown: diameter 35 cm
- Weighted base: 5.4 Kg, diameter 34 cm
- Umbrella stand: capacity 9 umbrellas
- Rotating head
- Available in two colors: black / mast black or black / mast gray metal
- Materials: steel drum with Epoxy paint / recyclable aluminum coat hooks / Polypropylene umbrella stand
- 2 years warranty
- Recyclability: disassemble and reintegrate into the material use circuit

Réf. product	Color	Height	Code EAN	EA by box
100340639	Black	170 cm	3595560009800	1 pc.
100340640	Black/ metal gray	170 cm	3595560009794	1 pc.



/SLIM

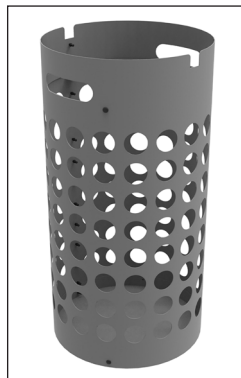

- **Versatility:** 2 hooks for folding umbrellas. At a height of 50 cm, this umbrella stand is ideal for long umbrellas (capacity of 9 umbrellas) and walking sticks.
- **Stable and easy to handle:** its metal base, with a felt pad to avoid scratching the wooden floors, is perfect for large areas.
- **Handy:** With two side handles, you can easily install it wherever you want.
- **Ventilation:** the multitude of perforations is ideal for drying umbrellas.

- Base: 0.35 Kg, diameter 26 cm
- Umbrella stand: capacity 9 umbrellas
- Available in two colors: black or gray
- Materials: steel base with epoxy paint / plastic drum Polypropylene
- 2 years warranty

Réf. product	Color	Height	Code EAN	EA by box
400109020	Black	50 cm	3595560027859	1 pc.
400109022	Gray	50 cm	3595560027866	1 pc.

/EXTEND



- **Functional:** this cloakroom has a telescopic upper bar adjustable in height and width to organize effortlessly and hang your clothes.
- **Versatile:** perfect for both individuals and professionals
- **Classic design:** made of aluminum, this black and chrome cloakroom will perfectly match your workspace.
- **Easy to move:** this locker is equipped with 4 swivel castors for effortless movement.
- **Easy assembly:** the assembly and disassembly is easy and fast to save time and space.

- 2.5 cm diameter steel tubes
- Height: min: 102 cm, max: 166 cm
- Length: mini: 80cm, max: 150 cm
- Depth: 42 cm
- Supports up to 40 hangers
- 2 years warranty
- Materials: high quality chrome steel and ABS plastic

KLASSIK coat hangers: Réf. 100340719	LOCKY coat hangers: Réf. 100340718	VESTA coat hangers: Réf. 100340725	WOODY coat hangers: Réf. 100340720
			
1 set of 20 pieces	1 set of 20 pieces	1 set of 25 pieces	1 set of 25 pieces

Réf. product	Color	Maximum load	Code EAN	EA by box
400074533	Black/chrome	20 Kg	3595560012459	1 pc.

/FOLDY

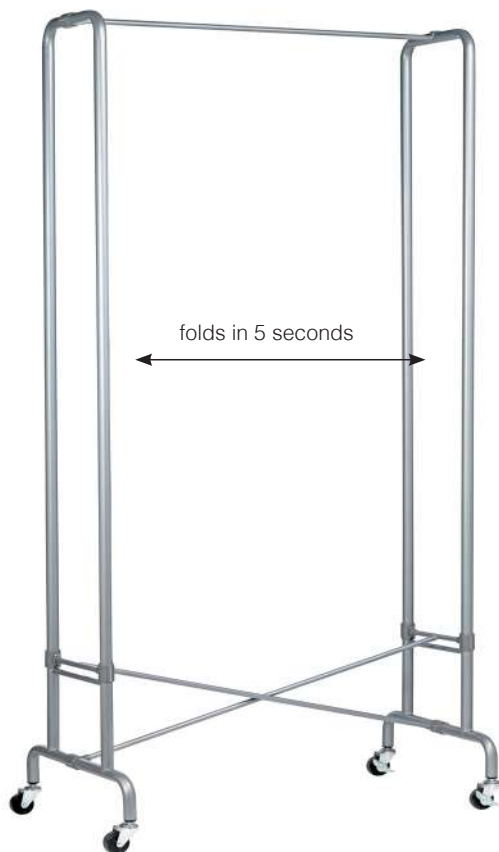

- **Functional:** Thanks to its folding system, the cloakroom deploys in seconds, without effort, for immediate use.
- **Versatile:** perfect for both individuals and professionals
- **Contemporary design:** Made of high quality steel, this foldable wardrobe will easily find its place in your workspace.
- **Easy assembly:** Assembly and disassembly is easy, fast and without tools, saving time and space.
- **Storage space:** this cloakroom can support a maximum load of 40 hangers.

- 2.5 cm diameter steel tubes
- Height: 180 cm
- Length: 88 cm
- Depth: 49 cm
- Supports up to 40 hangers
- 2 years warranty
- Materials: high quality steel with epoxy paint and ABS plastic (castors)

KLASSIK coat hangers: Réf. 100340719	LOCKY coat hangers: Réf. 100340718	VESTA coat hangers: Réf. 100340725	WOODY coat hangers: Réf. 100340720
			
1 set of 20 pieces	1 set of 20 pieces	1 set of 25 pieces	1 set of 25 pieces

Réf. product	Color	Maximum load	Code EAN	EA by box
400050665	Metal gray	20 Kg	3595560009350	1 pc.

/GROOM



- **Functional:** designed to store all types of clothing (coats, jackets), the lower shelf will be used to place items not suitable for hanging such as bags, helmets.
- **Versatile:** perfect for professional or home use.
- **Classic design:** solid, elegant, with an excellent quality / price ratio, this practical carrier for all occasions will adapt to any type of workspace.
- **Easy to move:** this locker is equipped with 4 swivel castors for effortless movement.

- 2.5 cm diameter steel tubes
- Height: 162 cm
- Length: 90 cm
- Depth: 42 cm
- Supports up to 40 hangers
- 2 years warranty
- Materials: high quality chromed steel and ABS plastics (wheels)



Réf. product	Color	Maximum load	Code EAN	EA by box
400050647	Chrome	70 Kg	400050647	1 pc.

/MEETING



















- **Functional:** has a crossbar 173 cm long to support clothes without damaging them.
- **Versatile:** perfect for both individuals and professionals
- **Modern design:** with sleek, contemporary lines, this rack is crafted from high-quality steel that will fit perfectly into your workspace.
- **Functions:** high quality swivel castors, additional upper gallery (max load of 70 hangers).
- **Assembly:** delivered with its mounting kit.

- 2.5 cm diameter steel tubes
- Height: 173 cm
- Length: 147 cm
- Depth: 50 cm
- Supports up to 70 hangers
- 2 years warranty
- Materials: high quality chrome steel, aluminum and ABS plastic (wheels)



















Réf. product	Color	Maximum load	Code EAN	EA by box
100340714	Metal gray	30 Kg	3595560007974	1 pc.

LAMPS	Color	SAP no.	Power (Watts)	Lux at 35 cm	lm/W*	Source's lifetime**	Color T°	CRI	Warranty	Energy class	EAN code	Page
 BRIO 2	Black	400093669	7	1830	130	50 000h	3500K	82	2 years	A/A+/A++	3595560014736	p 41
 CRISTAL LED	Metal gray	400064642	2x5 W E14	440	120	50 000h	3000K	82	2 years	A/A+/A++	3595560011551	p 75
 DISC	Black/ metal gray	100340421	6,1	1625	130	40 000h	3000K	82	2 years	A/A+/A++	3595560014859	p 44
 DIVA	Black	400124560	8,2	1150	100	30 000h	3000K 4000K 6000K	81	2 years	A/A+/A++	3595560029495	p 47
 DUO LED	Black	400093984	9,4	810	100	50 000h	3400K	81	2 years	A/A+/A++	3595560020874	p 36
 EASY	Black	400093833	10,4	1465	120	50 000h	3000K	84	2 years	A/A+/A++	3595560015580	p 52
 ERGOLIGHT	Black	100340991	9,6	840 (at 40 cm)	100	40 000h	3000K	83	2 years	A/A+/A++	3595560021062	p 38
 EYELIGHT	Black	400093835	9	1950	100	50 000h	2700K à 5200K	82	2 years	A/A+/A++	3595560015672	p 32
	Metal gray	400095547									3595560026005	
 FLEXIO 2	Black	400093687	5W E14	1395 (at 27 cm)	100	50 000h	3000K	82	2 years	A/A+/A++	3595560014750	p 54
	Metal gray	400093692									3595560014781	
	Green	400093694									3595560014941	
	Blue	400093695									3595560015382	
 FOLIA	Black	400020346	9,4	1480	100	40 000h	3000K	84	2 years	A/A+/A++	3595560002856	p 39
	White	100340438									3595560016174	
 ILLUSIO	Black	400036264	9,1	1410	100	40 000h	3650K	86	2 years	A/A+/A++	3595560006519	p 40
 INCLINEA	Brushed steel	400032358	12W E27	310	120	20 000h	3000K	82	2 years	A/A+/A++	3595560005536	p 76
 JACK	Black	400077430	6,2	925	108	40 000h	3000K 3500K 4000K	82	2 years	A/A+/A++	3595560012862	p 50
 JAZZ	White/ metal gray	400093836	13,7	1030	139	50 000h	3000K 4000K 5000K	88	2 years	A/A+/A++	3595560016327	p 69
 JOKERLED	Black	400064432	6,6	1760	130	40 000h	3000K	92	2 years	A/A+/A++	3595560011353	p 43
	Metal gray	400064434									3595560011377	
	Purple	400064436									3595560011384	
 JOKER halogène	Black	100340174	GY 6,35 35W	1030	NC	4 000h	2900K	98	2 years	B	3595560002672	On the website









* light emission of the lighting source





** Average consumption: 1000 h / year

LAMPS	Color	SAP no.	Power (Watts)	Lumens	lm/W*	Source's lifetime**	Color T°	CRI	Warranty	Energy class	EAN code	Page
LINKA 	Black	400124484	6,4	1695	111	50 000h	2800K 3400K 4500K 5600K	82	2 years	A/A+/A++	3595560029402	p 67
LUCY 	White	400093614	6,8	940	143	30 000h	3200K 4500K 5200K	82	2 years	A/A+/A++	3595560014675	p 53
	Black	400093640									3595560014705	
MAGIC 	Black	400016681	8,4	1810	100	40 000h	3000K	84	2 years	A/A+/A++	3595560002238	p 57
MAMBOLED 	Black	400033683	7	1235	110	40 000h	3000K	83	2 years	A/A+/A++	3595560005796	p 60
	Metal gray	400033684									3595560005802	
NELLY 	White	400124483	7,8	1100	134	20 000h	3000K 4000K 6000K	81	2 years	A/A+/A++	3595560029372	p 73
POPY 	Metal gray	400124478	6	1100	120	50 000h	3000K 4000K 6000K	81	2 years	A/A+/A++	3595560029433	p 71
ROMY 	Chrome	400077407	12,7	815	134	20 000h	3500K	82	2 years	A/A+/A++	3595560012831	p 77
RUMBALED 	Black	400093720	5,2	1090	135	50 000h	4000K	82	2 years	A/A+/A++	3595560015443	p 65
SENSATION 	Black	100340449	8,2	1285	100	40 000h	3000K	82	2 years	A/A+/A++	3595560015573	p 37
SENZA 2 	Metal gray	400092054	8	1140	130	50 000h	3000K 4500K 6500K	86	2 years	A/A+/A++	3595560014286	p 58
SOL 	Black	400077402	7,4	1260	120	20 000h	3000K	82	2 years	A/A+/A++	3595560012794	p 55
	White	400077404									3595560012800	
	Red	400077406									3595560012824	
	Blue	400077405									3595560012817	
STRATA 	Black	400124562	12,7	1170 (at 50 cm)	100	50 000h	3000K à 6000K	82	2 years	A/A+/A++	3595560029525	p 35
SUCCESS 66 	Black	400093600				BULB NOT SUPPLIED			2 years		3595560014552	p 64
SUCCESS 80 	Black	400093579				BULB NOT SUPPLIED			2 years		3595560014613	p 64
	White	400093610									3595560014644	
SUCCESS 80 chrome 	Chrome	400092123	10W E27	1640	100	30 000h	3000K	82	2 years	A/A+/A++	3595560014255	p 63
SUCCESS 105 	Black	400093996	10W E27	1640	100	30 000h	3000K	82	2 years	A/A+/A++	3595560020959	p 61















* light emission of the lighting source

** Average consumption: 1000 h / year

LAMPS	Color	SAP no.	Power (Watts)	Lux at 35 cm	lm/W*	Source's lifetime**	Color T°	CRI	Warranty	Energy class	EAN code	Page
 SUNLIGHT	Black	400110128	9	1480	100	50 000h	2700K à 5200K	82	2 years	A/A+/A++	3595560028030	p 33
 SWINGO LED	Black	400093838	11	1710	120	50 000h	3000K	82	2 years	A/A+/A++	3595560016495	p 59
	White	400093839									3595560016570	
 TERRA	Metal gray	400077409	8,3	1120	134	40 000h	3300K	82	2 years	A/A+/A++	3595560012855	p 70
 TIMELIGHT	Black	400110241	9	1450	100	50 000h	2700K à 5200K	82	2 years	A/A+/A++	3595560028085	p 31
 ULVA	Metal gray	400012753	5,4	1700 (at 40 cm)	100	20 000h	3000K	86	2 years	A/A+/A++	3595560000128	p 51
 URBAN	White	400093963	10,9	1580	120	50 000h	2900K	82	2 years	A/A+/A++	3595560017782	p 45
 VICKY	White/ beech	400110084	11	2520	120	50 000h	3000K	82	2 years	A/A+/A++	3595560028139	p 49
 MINI ZOOM LED	White	400108074	5,9	1890	130	50 000h	6700K	82	2 years	A/A+/A++	3595560027699	p 80
	Black	400110245									3595560028122	
 ZOOM LED	White	400108073	7,7	1950	100	50 000h	6200K	83	2 years	A/A+/A++	3595560027682	p 81

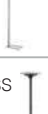
UPLIGHTERS & PENDANTS	Color	SAP no.	Power (Watts)	Lux at 55 cm (indirect)	Lm/W*	Source's lifetime**	Color T°	CRI	Warranty	Energy class	EAN code	Page
 ARIUS	White	Consult us	55	2100 893 at 110 cm (direct)	130	50 000h	4000K	82	2 years	A/A+/A++	NC	p 14
 ARIUS pendant	White	Consult us	NC	NC NC at 110 cm (direct)	NC	NC	4000K	NC	2 years	A/A+/A++	NC	p 14
 ORIOUS	White	Consult us	90,6	2984 1190 at 110 cm (direct)	140	50 000h	4000K	90	2 years	A/A+/A++	NC	p 13
 ORIOUS pendant	White	Consult us	NC	NC NC at 110 cm (direct)	140	NC	4000K	NC	2 years	A/A+/A++	NC	p 13



* light emission of the lighting source
** Average consumption: 1000 h / year

UPLIGHTERS	Color	SAP no.	Power (Watts)	Lux at 55 cm (indirect)	lm/W*	Source's lifetime**	Color T°	CRI	Warranty	Energy class	EAN code	Page
CRISTALIA Halogen 	Metal gray	100340573	230 (230 W RST halogen tube supplied)	2800	NC	2 000h	3000K	98	2 years	C	3595560006601	p 29
DELY 	Black	400050389	31,9	2870	134	40 000h	3100K	81	2 years	A/A+/A++	3595560008612	p 26
	Metal gray	400094197									3595560021154	
DELY articulated 	Black	400070582	31,9	2870	134	40 000h	3100K	81	2 years	A/A+/A++	3595560010905	p 26
	Metal gray	400094198									3595560021529	
DELY chrome 	Chrome	400069146	31,9	280	134	40 000h	3100K	81	2 years	A/A+/A++	3595560012053	p 27
FIRST Halogen 	Black	100340557	230 (230 W RST halogen tube supplied)	2800	NC	2 000h	3000K	99	2 years	C	3595560007240	p 28
	Metal gray	100340559									3595560006595	
FIRST articulated Halogen 	Black	100340570	230 (230 W RST halogen tube supplied)	2800	NC	2 000h	3000K	99	2 years	C	3595560008421	p 28
INCLINEA 	Brushed steel	400032380	11W E27	NC	NC	50 000h	3000K	>80	2 years	A/A+/A++	3595560005529	On the website
LEDDY 	Black	400124563	29	3160	120	40 000h	3000K	83	2 years	A/A+/A++	3595560029556	p 25
LIXUS 	Metal gray	400079771	68,4	3600 (1195 at 110 cm direct)	123	40 000h	4000K	>80	2 years	A/A+/A++	3595560011155	p 15
PRYSKA 	White/ beech	400110157	44,6	5300	120	40 000h	3000K	83	2 years	A/A+/A++	3595560028047	p 21
STRATUS 	Metal gray	400124564	58,8	320 835 at 110 cm (direct)	85	40 000h	4000K	83	2 years	A/A+/A++	3595560029587	p 17
VARIAGLASS 	Black	400090472	30,7	2870	120	40 000h	3200K	82	2 years	A/A+/A++	3595560014088	p 19
	Metal gray	400090473									3595560014095	
VARIALUXLED 	Black	400090467	29,9	2820	120	40 000h	3000K	82	2 years	A/A+/A++	3595560014040	p 22
	Metal gray	400090468									3595560014057	
VARIALUXLED articulated 	Black	400090469	29,9	2820	120	40 000h	3000K	82	2 years	A/A+/A++	3595560014064	p 23
	Metal gray	400090471									3595560014071	
ZELUX 	Metal gray	400100711	44	4100	120	40 000h	3000K	82	2 years	A/A+/A++	3595560027002	p 18

* light emission of the lighting source

** Average consumption: 1000 h / year

ERGONOMIC ACCESSORIES	Color	SAP no.	Dimensions	Main features	Weight	Warranty	EAN code	Page
 <p>ERGO DESK 2</p>	Black	400124576	72 cm x 50 cm x 12 cm	Station sitting / standing Gas spring adjustment This workstation will make you more dynamic and productive	12,8 Kg	2 years	3595560029761	p 104
 <p>ERGO ONE</p>	Black	400124578	44 cm x 40 cm x 11 cm	Single arm support 2 USB 3.0 ports Improves your posture and reduces cervical tension	2,4 Kg	2 years	3595560029822	p 92
 <p>ERGO TWIN</p>	Black	400124579	44 cm x 40 cm x 11 cm	Double arm support 2 USB 3.0 ports Improves your posture and reduces cervical tension	4,2 Kg	2 years	3595560029853	p 93
 <p>ERGO STATION</p>	White	400124600	125 cm x 40 cm	Ergonomic desk organizer single arm support delivered with 3 storage accessories	8 Kg	2 years	3595560029884	p 94
 <p>ERGO WELL</p>	White/ beech	400124577	160 cm x 80 cm x 65 cm	Electric desk Adjustment from 62 cm to 128 cm 3 position memory Anti-collision alert	55 Kg	2 years	3595560029792	p 105
 <p>LALY</p>	Black	400095693	15 cm x 5 cm	Speaker Bluetooth connection Double speakers 2 x 3 W Wireless induction charger	0,45 Kg	2 years	3595560025600	On the website
 <p>MOOVE</p>	Black	400110242	35 cm x 63 cm	Dynamic stool Adjustable from 63 cm to 89 cm Supports a weight up to 150 Kg Fight against a sedentary lifestyle	9,6Kg	2 years	3595560028092	p 102
 <p>ROLLING</p>	Black	4001110158	12 cm x 11 cm x 4 cm	Wrist rest Memory foam mobile on 4 steel balls Against carpal tunnel syndrome	0,06 Kg	2 years	3595560028061	p 95
 <p>STUDY</p>	Metal gray/ white	400095491	62 cm x 17 cm x 5 cm	Non-adjustable screen support 4 USB 2.0 ports reduces cervical tension	0,68 Kg	2 years	3595560025848	On the website





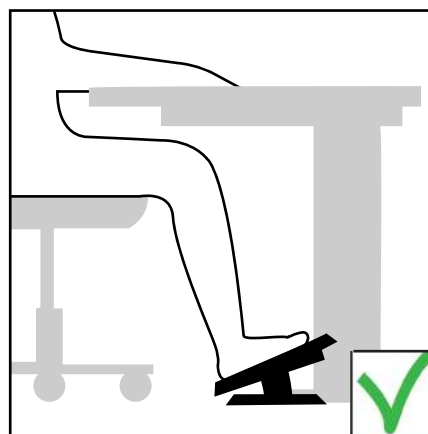
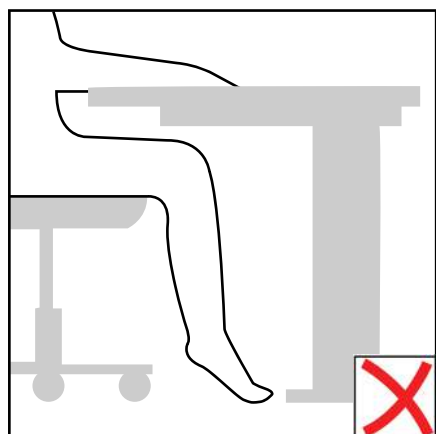

AIR PURIFIERS	Color	SAP no.	Dimensions	Main features	Weight	Warranty	EAN code	Page
 <p>AUBE</p>	White/ chrome	400124565	10 cm x 10 cm x 10 cm	Air purifier Photocatalytic system Powerful and silent USB charging	0,52 Kg	2 years	3595560029617	p 114
 <p>R'CLEAN</p>	White/ metal gray	400110240	34 cm x 22 cm	Air purifier 4 filtration systems Luminous indicator of the quality of the air	1,8 Kg	2 years	3595560028078	p 113
 <p>R'PURE</p>	White/ black	400095490	30 cm x 15 cm x 6 cm	Air purifier Ionizer system Powerful and silent Horizontal or vertical use	0,62 Kg	2 years	3595560025817	p 112

/Reminder

















Why use a footrest?











You have to define your needs. That's why we advise you on the elements to take into account to choose the ergonomic footrest. An ergonomic footrest is to be considered at the same level as ergonomic mice or ergonomic stools. The use of a footrest is really necessary. People will compensate for the fact that they do not touch the ground by an inappropriate and inappropriate position. Thanks to the footrests, these people will be in contact with the ground, feet flat and knees at the right angle of 90°.







FOOTRESTS	Color	SAP no.	Dimensions	Tilt	Height	Weight	Warranty	EAN code	Page
CHOCOLATE 	Black	100340816	42 cm x 32 cm	0° to 25°	11 cm to 16 cm	1,45 Kg	10 years	3595560015931	p 99
CHRYSALIS 	Black	100340820	42 cm x 32 cm	10°; 15°, 20°	10 cm x 13,5 cm	0,63 Kg	10 years	3595560009817	p 98
CONFORT MASSANT 	Black	100340817	45 cm x 30 cm x 12 cm	10°	12 cm	1,32 Kg	10 years	3595560001194	p 97
NYMPHEA 	Black	100340822	42 cm x 32 cm	0° to 20°	12 cm à 17cm	0,97 Kg	10 years	3595560009824	p99
ORIGIN 	Black	100340819	45 cm x 35cm x 13,5 cm	10° and 15°	max 13,5cm	1,0 Kg	10 years	3595560010219	p 98
ROLLER FEET 	Black	400125220	44 cm x 14 cm	No	14 cm	1,3 Kg	2 years	3595560029914	p 101
UPDOWN 	Black	400095456	45 cm x 30 cm x 8 cm	0° to 25°	8 cm	0,93 Kg	10 years	3595560025732	p 100

CLOCKS	Color	SAP no.	Diameter	Second hand	Main features	readability	Warranty	EAN code	Page
ARIA 	Metal gray	4000942880	28 cm	Yes	Quartz system	30 m	2 years	3595560022366	p 118
ATTRACTION 	Metal gray	400094404	22 cm	Yes	Quartz system Silencieuce Magnetic	22 m	2 years	3595560023318	p 125
BALTIC 	Beech	400094591	31,5 cm	Yes	Quartz system Silent	35 m	2 years	3595560025251	p 124
FLO LED 	Black	400124566	28 cm x 28 cm	Yes	LED display retro lighting time / date / temperature Silent	NC	2 years	3595560029648	p 125
INSTINCT 	Metal gray	100340853	30,5 cm	Yes	DST technology Digital date	35 m	2 years	3595560007929	p 119
MAGNET 	Metal gray	400094406	30,5 cm	Yes	Quartz system Magnetic	30 m	2 years	3595560023714	p 118
MAXI POP 	Black	400094487	37,5 cm	Yes	Quartz system Silent	150 m	2 years	3595560023905	p 122
	Metal gray	400094488						3595560023936	
MAXI WAVE 	Black	400094564	37,5 cm	Yes	Technology Radio Controlled	150 m	2 years	3595560024919	p 126
	Metal gray	400094565						3595560024940	
MEGA 	Black	400094568	57,5 cm	Yes	Quartz system	180 m	2 years	3595560025183	p 121
MOON 	Metal gray	400094569	30,5 cm	Yes	Quartz system Backlighting	35 m	2 years	3595560025220	p 120
ON TIME 	Black	400094567	30,5 cm	Yes	Quartz system 4 zone display	30 m	2 years	3595560025114	p 121
OUTDOOR 	Metal gray	400094566	35,5 cm	Yes	Technology Radio Controlled Silent Waterproof	100 m	2 years	3595560025053	p 127
POP 	Black	400094281	28 cm	Yes	Quartz system Silent	30 m	2 years	3595560022496	p 122
	White	400094282						3595560022618	
	Metal gray	400094283						3595560022656	
	Blue	400094560						3595560024070	
	Green	400094284						3595560022663	
	Purple	400094285						3595560022854	
STATION 	Metal gray	400124567	35 cm	Yes	Technology Radio Controlled Silent	35 m	2 years	3595560029679	p 127
TEMPUS 	Metal gray	400094592	30,5 cm	Yes	Quartz system Temperature display	25 m	2 years	3595560025282	p 119
WAVE 	Black	400094561	30 cm	Yes	Technology Radio Controlled	35 m	2 years	3595560024186	p 126
	White	400094563						3595560024711	
	Metal gray	400094562						3595560024445	

COAT STANDS	Color	SAP no.	Coat pegs numbers	Umbrella stand capacity	Revolving head	Warranty	EAN code	Page
ACCESS 	Black	400095391	6	6	No	2 years	3595560025398	p 134
	White/ beech	400095392					3595560025411	
ACCUEIL 	Black	100340694	8	6	Yes	2 years	3595560008827	p 137
	White	100340696					3595560008858	
	Metal gray	100340698					3595560008872	
	Blue	400095390					3595560025374	
	Green	400017761					3595560002627	
	Ourple	400095219					3595560024803	
ACCUEIL chrome 	Chrome	100340697	8	6	Yes	2 years	3595560008865	p 137
ACCUEIL bois 	Black/ beech	100340701	8	6	Yes	2 years	3595560009251	p 137
	Black/cherrish	100340700					3595560009244	
	Gray/ beech	100340704					3595560009237	
	Gray/ cherrish	100340703					3595560009220	
ADVANTAGE 	Black	100340648	6	9	Yes	2 years	3595560006977	On the website
	Blue	100340644					3595560006939	
BOUQUET 	Metal gray/ beech	400069048	6	6	No	2 years	3595560011933	p 136
	Metal gray/ green	400079775					3595560013005	
	Metal gray/ burgundy	400079772					3595560012992	
CYPRES 	Black	100340639	24	9	Yes	2 years	3595560009800	p 139
	Metal gray	100340640					3595560009794	
ELANCIAL 	Gray/ black	400106609	6	6	Yes	2 years	3595560002900	p 136
	Gray/ white	400106744					3595560027637	
	Gray/ green	400106746					3595560027651	
	Gray/ blue	400106745					3595560027644	
FLORA x3 	Black	100340710	3	/	Yes	2 years	3595560015740	p 138
FLORA x6 	Black	100340711	6	9	Yes	2 years	3595560015757	p 138
	Metal gray	100340712					3595560015825	
HAKEA 	Black/ chrome	400095393	12	6	Yes	2 years	3595560025435	p 138
MIKADO 	Beech	400124574	8	0	No	2 years	3595560029709	p 135
SPIRIT 	Metal gray	100340626	6	0	No	2 years	3595560007196	On the website
TIPY 	Bamboo	400124575	4	0	No	2 years	3595560029730	p 134
SLIM porte-paraluit 	Black	400109020	/	9	/	2 years	3595560027859	p 141
SLIM porte-paraluit 	Gray	400109022	/	9	/	2 years	3595560027866	p 141

COAT PEGS	Color	SAP no.	Coat pegs capacity	Maximum load	Warranty	EAN code	Page												
FIL 	Black	100340652	1 x 2	50 Kg	2 years	3595560001293	p 130												
FIL 	Black	100340662	2 x 2			3595560001385		3595560025510											
	Blue	400095398							3 x 2	3595560001460	3595560025602								
FIL 	Black	100340674	3 x 2			3595560025572													
	Green	400095451						Fil mutiple 				3595560001521	3595560016082						
	Blue	400095450							6 x 2	50 Kg	2 years			3595560025657					
	Green	400095453	Fil magnétique 	3595560004430	3595560009671														
	Blue	400095452				1	12 Kg	2 years				3595560025701							
	Black	100340762	2 x 2	40 Kg	2 years								3595560026241						
HAKEA 	Metal gray/ black	400095645				3 x 2	3595560026258												
	Metal gray/ black	400095646						5 x 2	3595560026265										
	Metal gray/ black	400095647	1 x 2	50 Kg	2 years					3595560004850									
STEELY 	Black	100340731				1 x 2	50 Kg	2 years	3595560011636										
	White	400064681									1	12 Kg	2 years	3595560004874					
	Metal gray	100340732													STEELY magnetic 	3595560011629	3595560011643		
	Green	400064680																3595560004881	3595560011599
	Purple	400064682																	
	Black	100340733	400064648	CYPRES 															
	White	400064647			2 x 3	50 Kg	2 years	3595560009589											
	Metal gray	100340734							4 x 3	3595560009879									
	Green	400064646			Metal gray/ black	100340804	100340805	2 years			3595560009879								
	Purple	400064648							1	NC		2 years	3595560008643						
CYPRES 	Metal gray/ black	100340804			2 x 3	50 Kg	2 years	3595560009589											
	Metal gray/ black	100340805	4 x 3	3595560009879															
TRIO magnétique 	Black	100340775			1	NC	2 years	3595560008643	On the website										

GARMENT RACKS	Color	SAP no.	Maximum load	Coat hangers capacity	Height	Warranty	EAN code	Page
EXTEND 	Chrome/ black	400074533	20 Kg	40	102 cm à 166 cm	2 years	3595560012459	p 142
FOLDY 	Chrome	400050665	20 Kg	40	180 cm	2 years	3595560009350	p 142
GROOM 	Chrome	400050647	70 Kg	40	162 cm	2 years	3595560009190	p 143
MEETING 	Metal gray	100340714	30 Kg	70	173 cm	2 years	3595560007974	p 143

/ Coming soon on pCon Planner

You will be able to obtain data on about 20 UNILUX products also in the OFML standard and integrate them quickly and easily into 3D space and layout designs via pCon.



/ Download on our website

Always available: high quality photos, technical data sheets and instruction manuals for all our products.



/ Do you have questions about our products?

Our customer service department is always at your disposal
Tél: +33 1 81 86 06 03
www.my-unilux.com, rubric SAV
E-mail: contact.unilux@hamelinbrands.com



/ Follow us on social networks

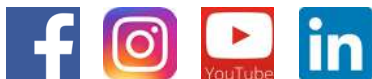

/ UNILUX

17 avenue du parc
91380 Chilly Mazarin
Tél: +33 1 81 86 06 00 - FRANCE
E-mail: contact.unilux@hamelinbrands.com